

Q: Why do the Earth & planets have
ionospheres? magnetospheres?

Dana Longcope

Montana State University

w/ liberal “borrowing” from Fuller-Rowel,
Solomon, Sojka, Lean, Vasylinunas,
Bagenal, Luhman

Heliophysics chain

Q: Why do the Earth & planets have ionospheres?

A: Because of the **Sun's corona** (its EUV & X-rays)

Q: Why does the Sun have a corona?

A: Because of its **magnetic field** (and its heating)

Q: Why does the Sun have a magnetic field?

A: Because of its **dynamo**

Earth's neutral atmosphere

	Earth
N ₂	77%
O ₂	21%
H ₂ O	1%
CO ₂	0.03%

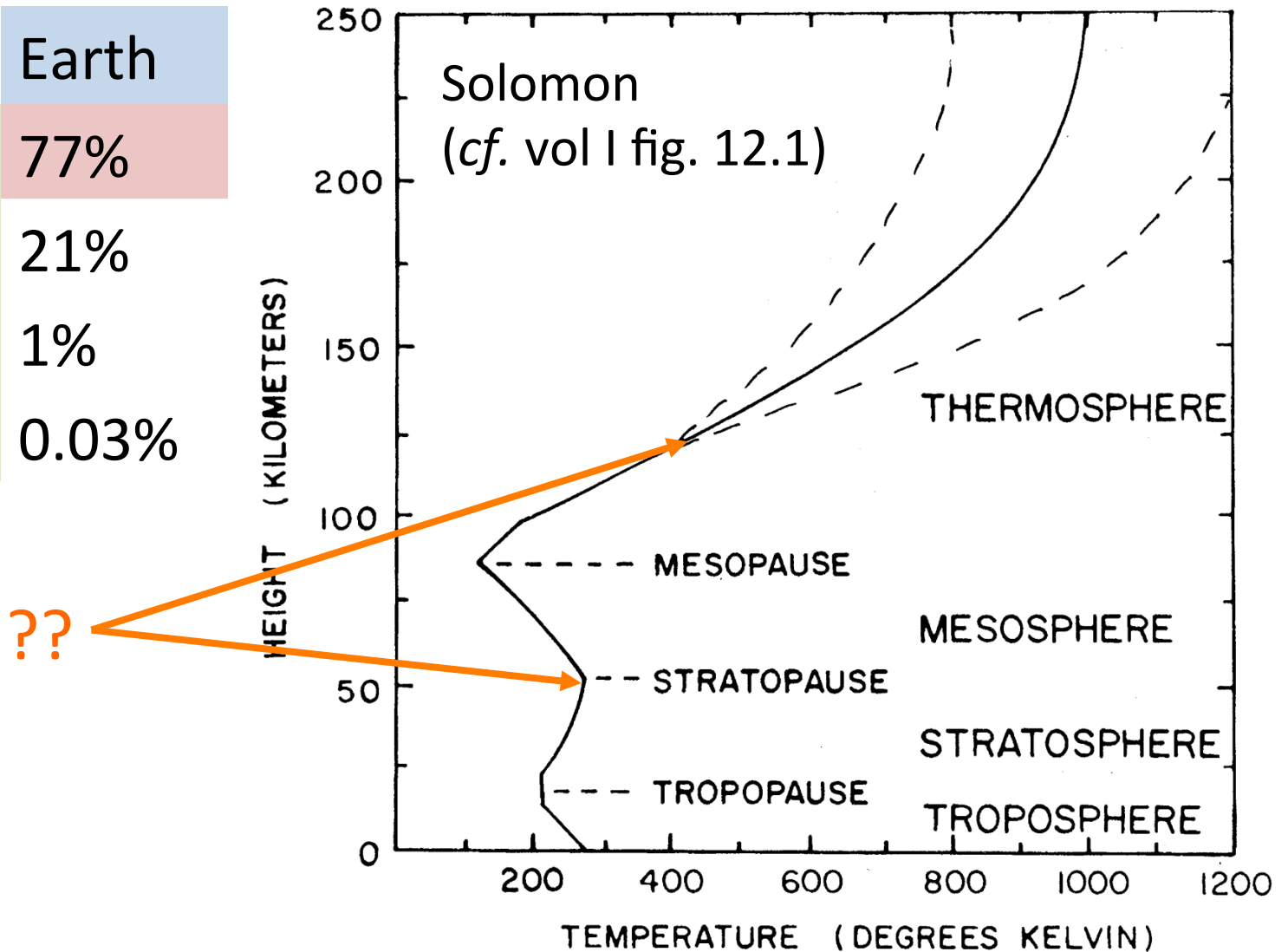

vol. III fig. 13.3

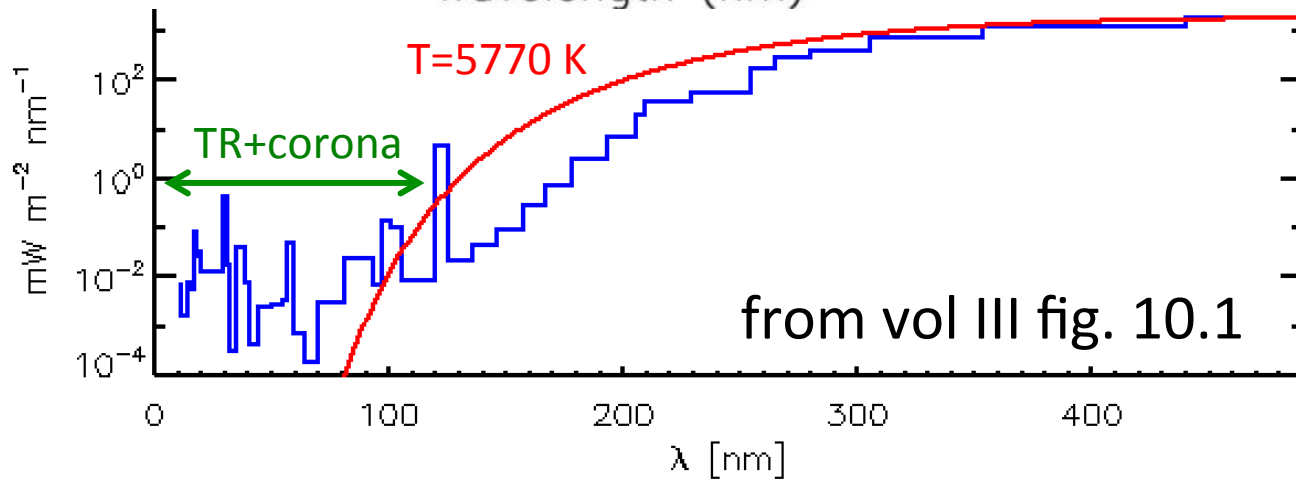
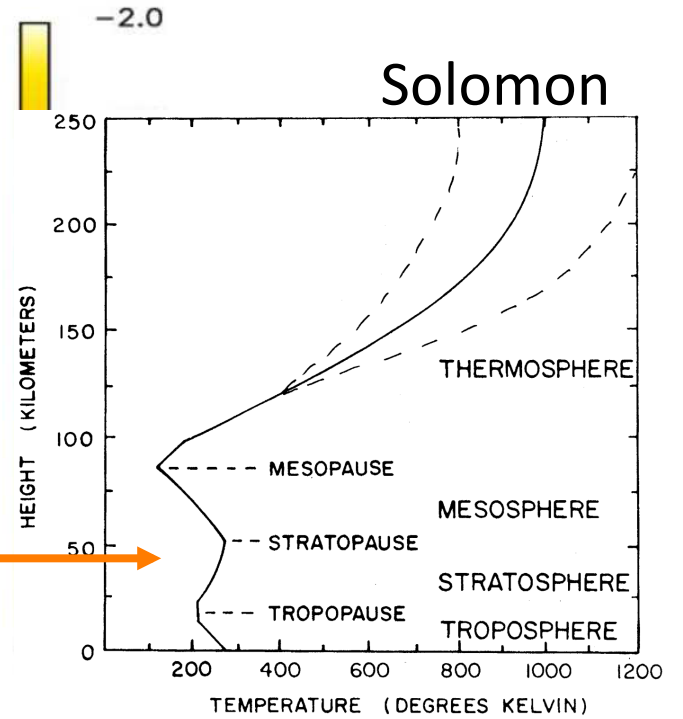
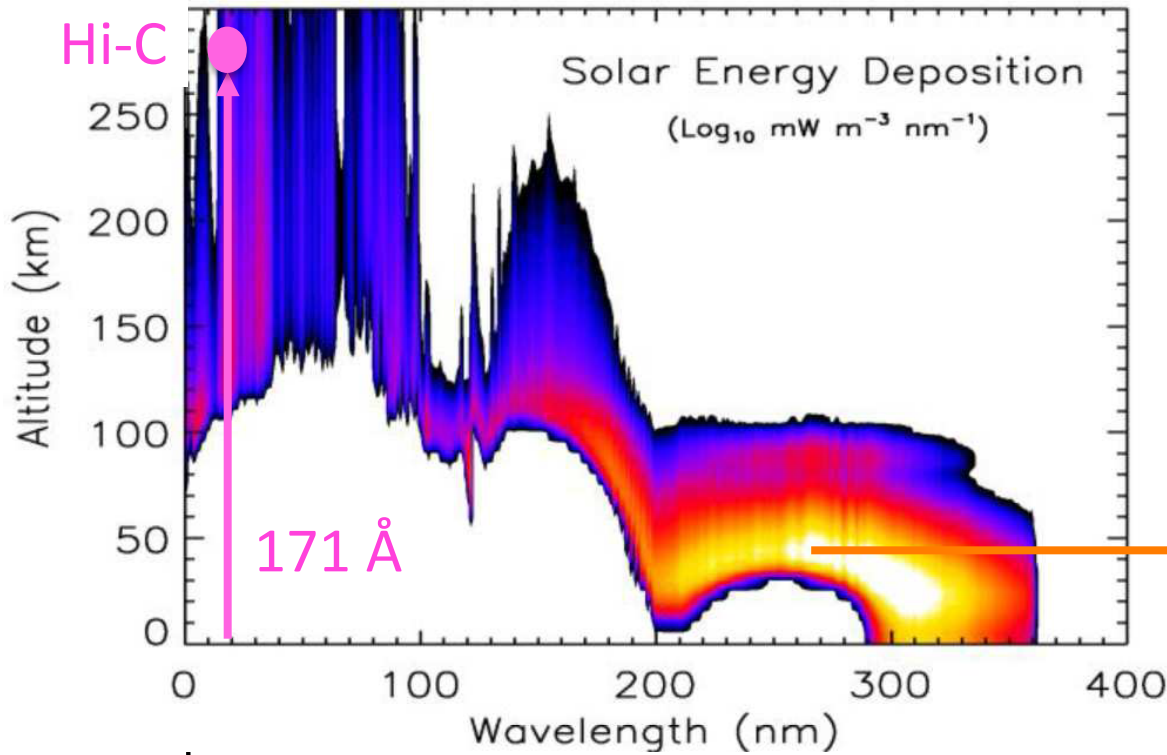

Fate of a photon

w/ absorption x-section σ

optical path $\tau(x)$ = avg. # absorbers in cylinder w/ x-section σ

Prob. of survival: $P(x) = \exp\left[-\int_0^x \sigma n(l) dl\right]$

$\tau=1 \rightarrow$ 1 absorber: mean-free path

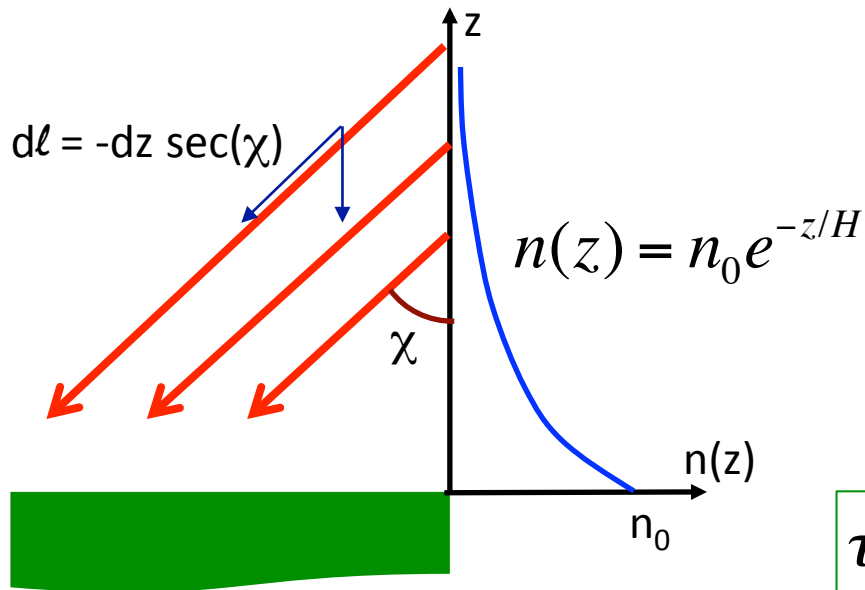

$$\tau(z) = \int_z^\infty \sigma n(z') \sec(\chi) dz'$$

$$= \sigma n_0 \sec(\chi) \int_z^\infty e^{-z'/H} dz'$$

$$\tau(z) = \sigma n_0 H \sec(\chi) e^{-z/H} = e^{-(z-z_{\tau 1})/H}$$

height of $\tau=1$: $z_{\tau 1} = H \ln[\sigma n_0 H \sec(\chi)]$

Prob. of survival: $P(z) = e^{-\tau(z)} = \exp\left[-e^{-(z-z_{\tau 1})/H}\right]$

$$e^{z_{\tau 1}/H} = \sigma n_0 H \sec(\chi) = \frac{\sigma n_0 k T}{\bar{m} g} \sec(\chi) = \sigma \frac{p_0}{\bar{m} g} \sec(\chi) = \frac{\sigma}{\sigma_0} \sec(\chi)$$

$$\sigma_0 = \frac{\bar{m} g}{p_0} = \frac{5 \times 10^{-23} \text{ g} \cdot 980 \text{ cm/s}^2}{10^6 \text{ erg/cm}^3} = 5 \times 10^{-26} \text{ cm}^2$$

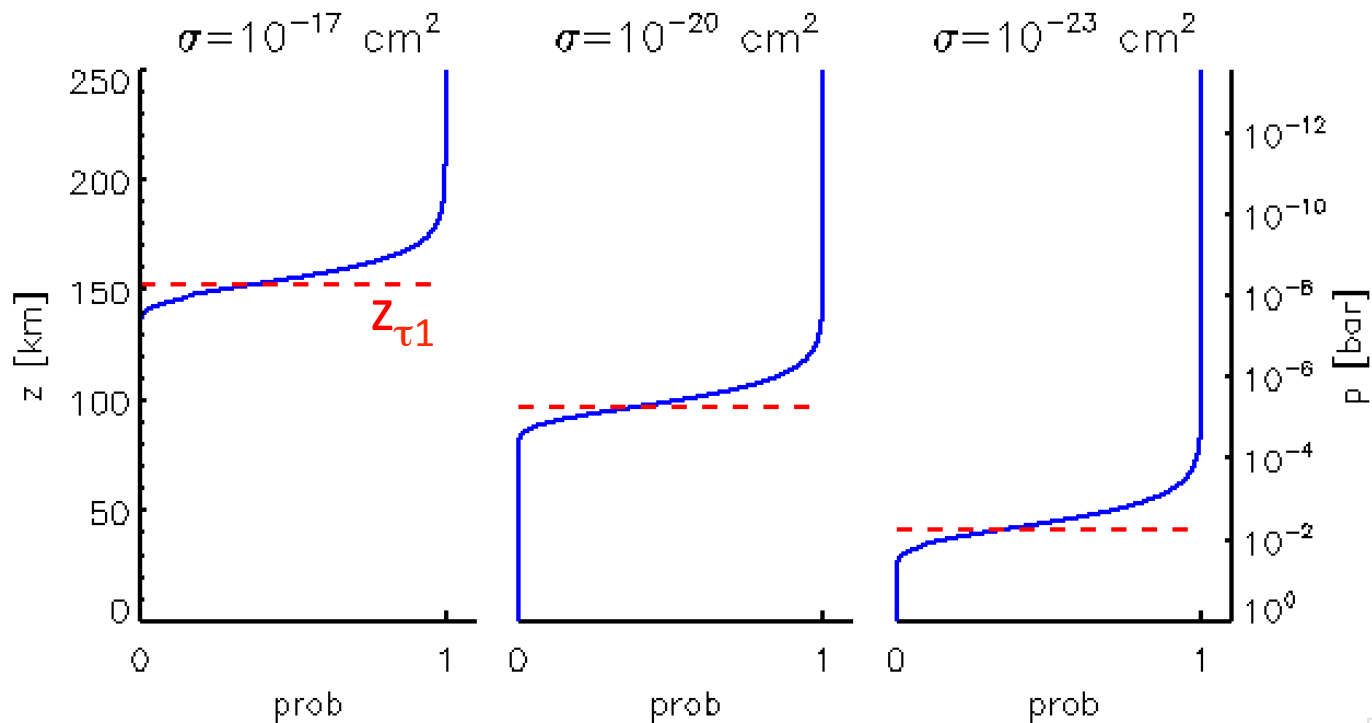

$$P(z) = e^{-\tau(z)} = \exp\left[-e^{-(z-z_{\tau 1})/H}\right]$$

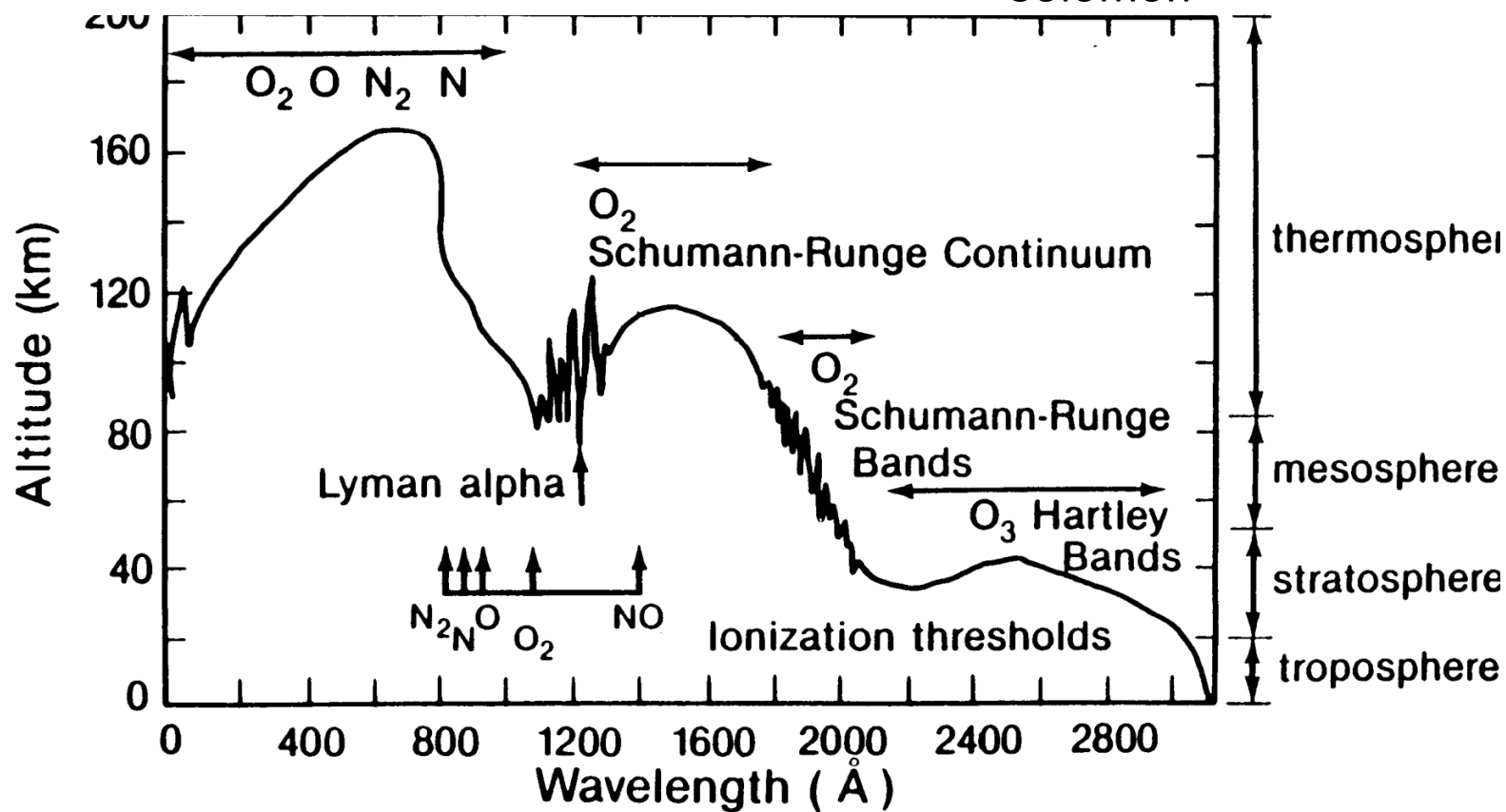
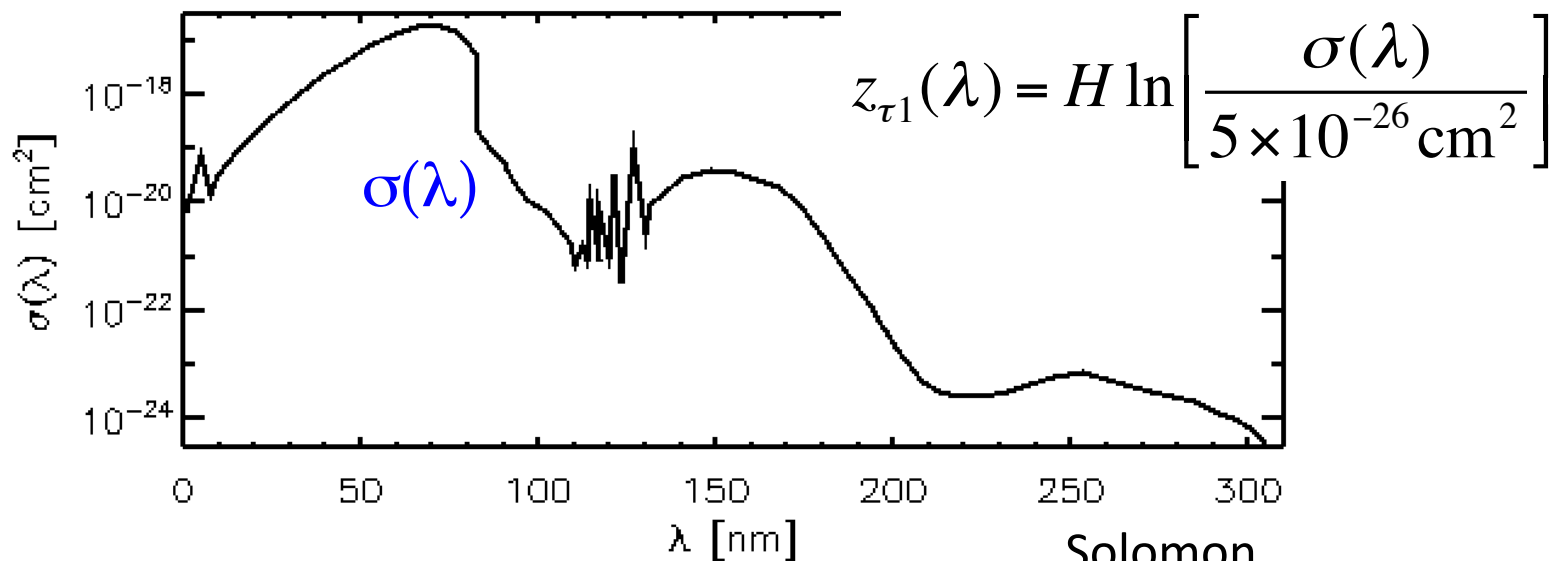

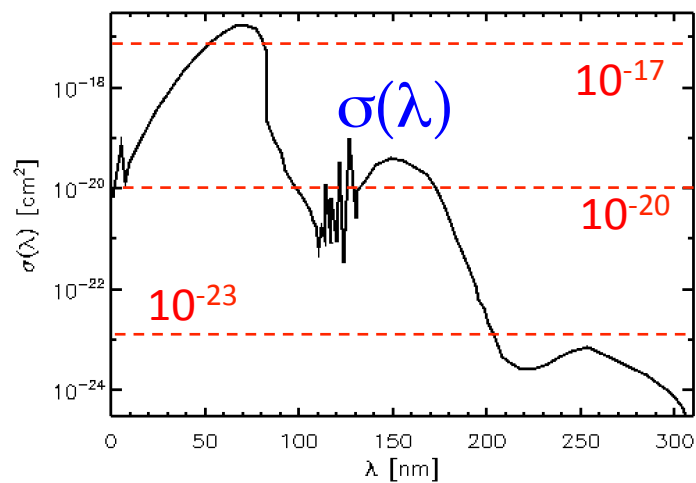
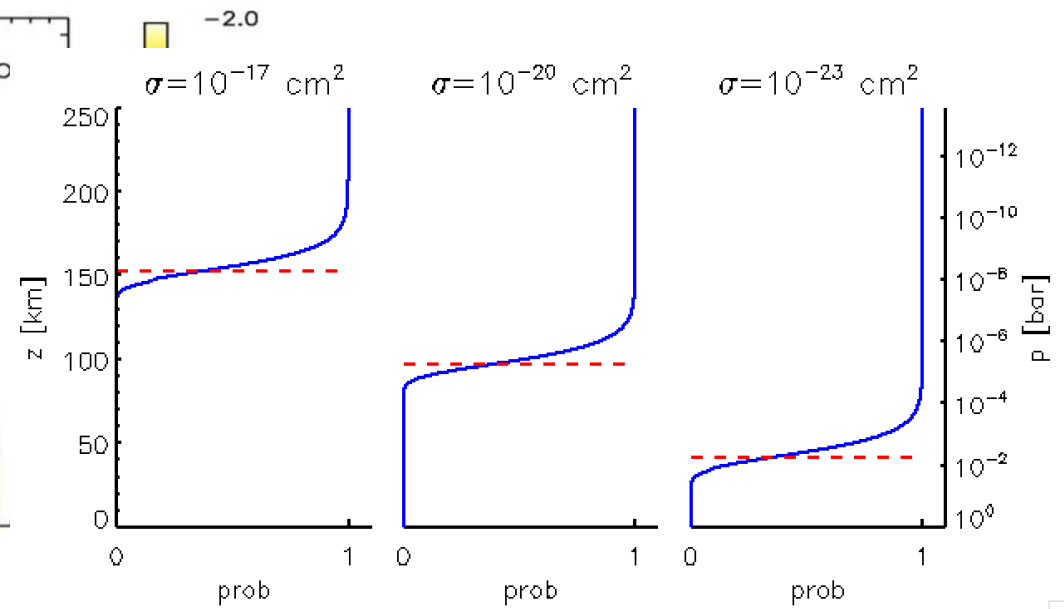
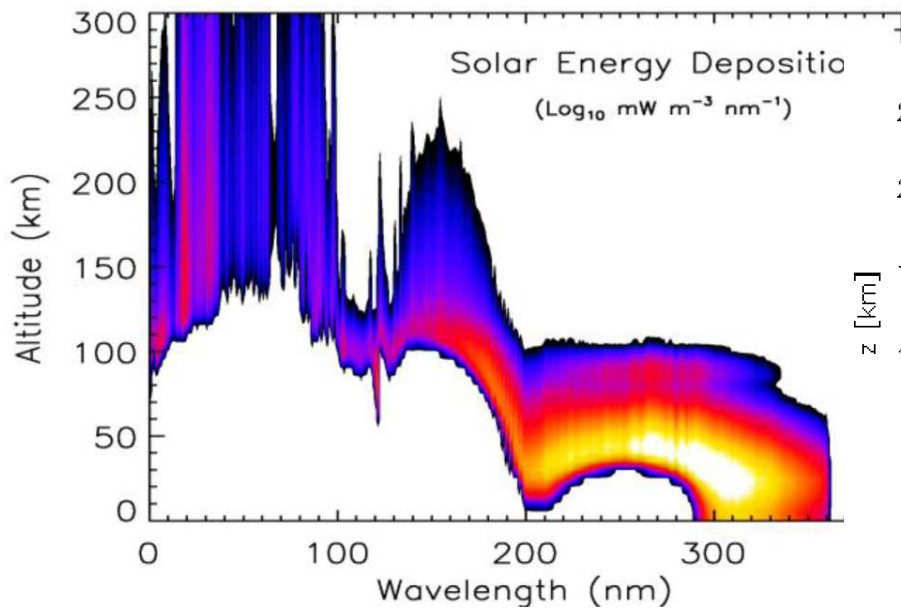

$$P[z(\lambda)] = \exp\left[-e^{-[z-z_{\tau 1}(\lambda)]/H}\right]$$

$$z_{\tau 1}(\lambda) = H \ln\left[\frac{\sigma(\lambda)}{5 \times 10^{-26} \text{ cm}^2}\right]$$

Radiation intensity & heating

Energy flux: $I(z) = I_\infty P(z) = I_\infty \exp\left[-e^{-(z-z_{\tau 1})/H}\right]$

Energy deposition: $\frac{dI}{dz} = \frac{I_\infty}{H} \exp\left[-e^{-(z-z_{\tau 1})/H} - \frac{z-z_{\tau 1}}{H}\right]$

Chapman layer

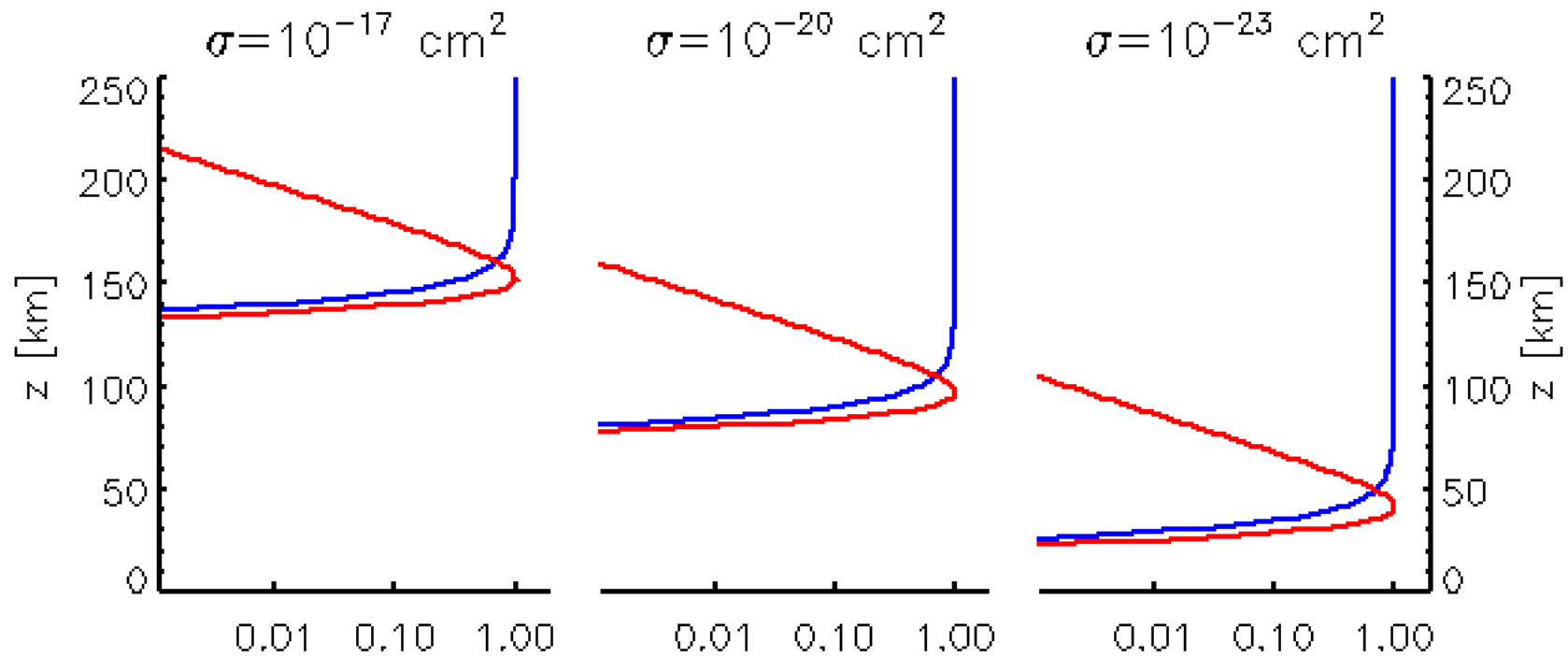

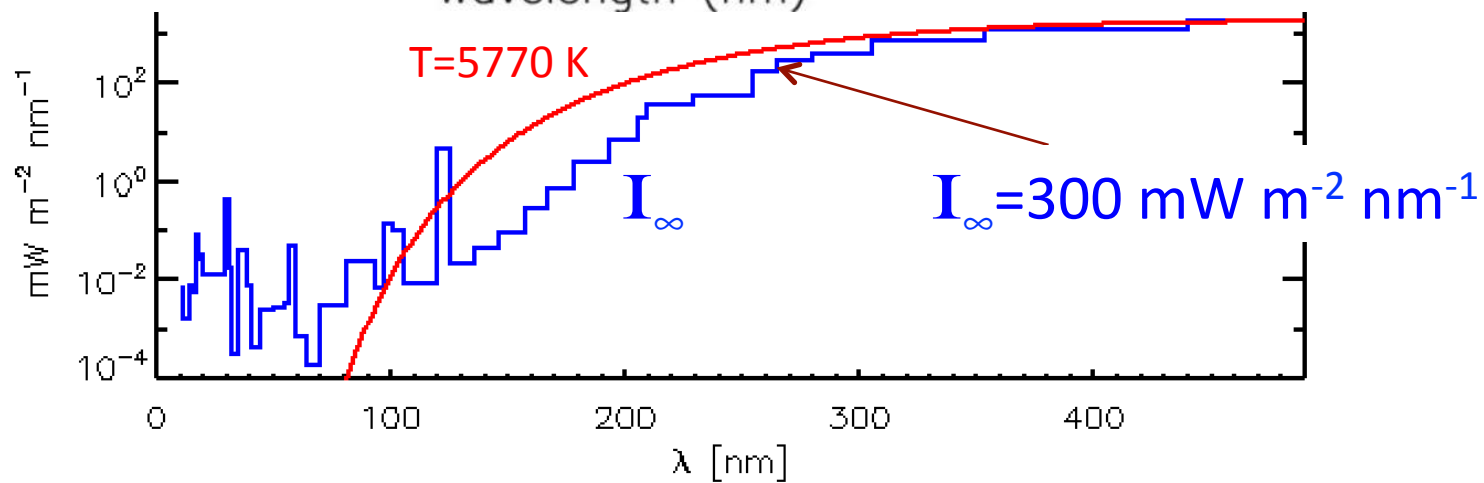
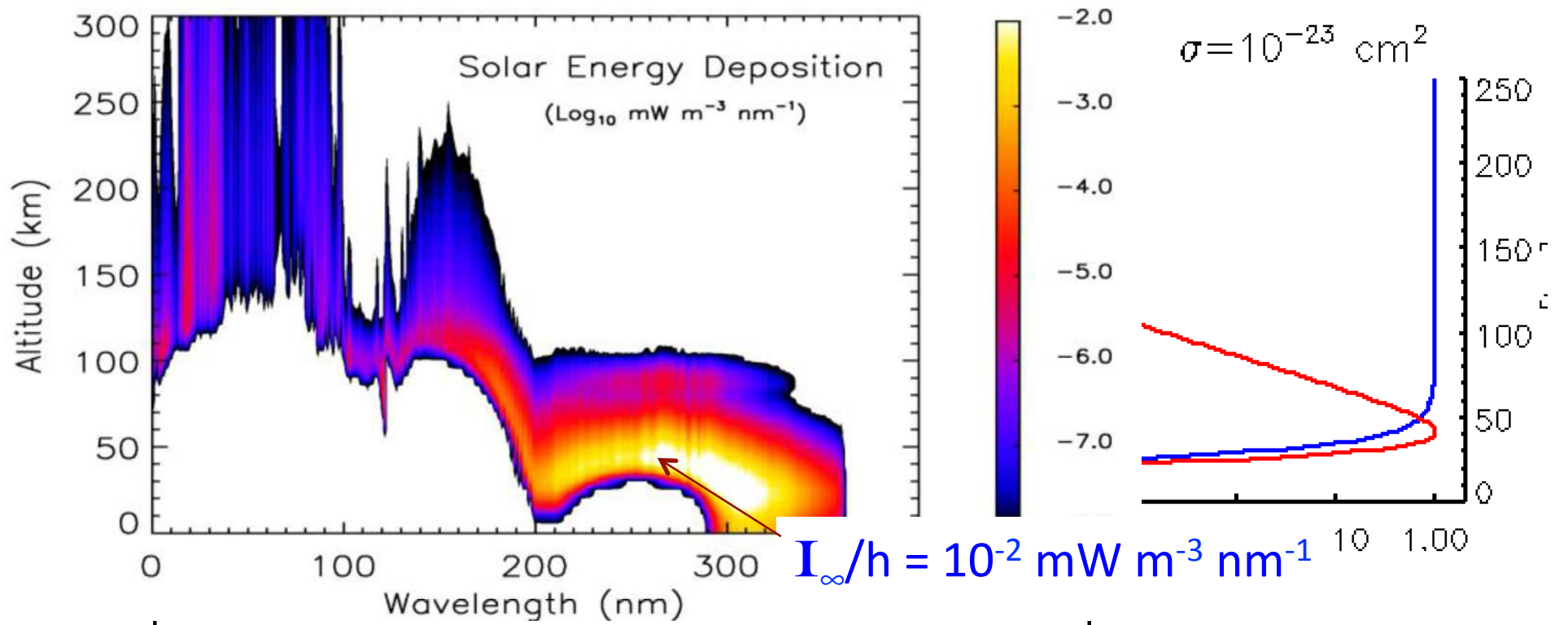

Absorption via ionization creates ion/electron pairs

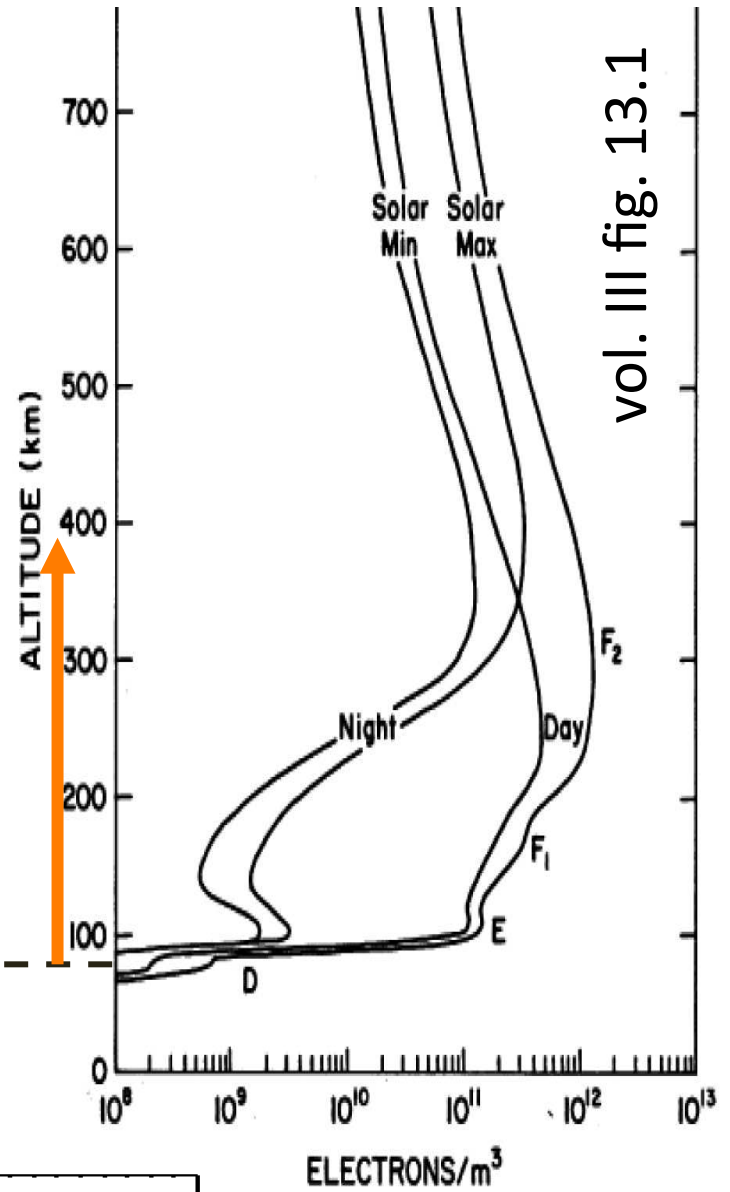
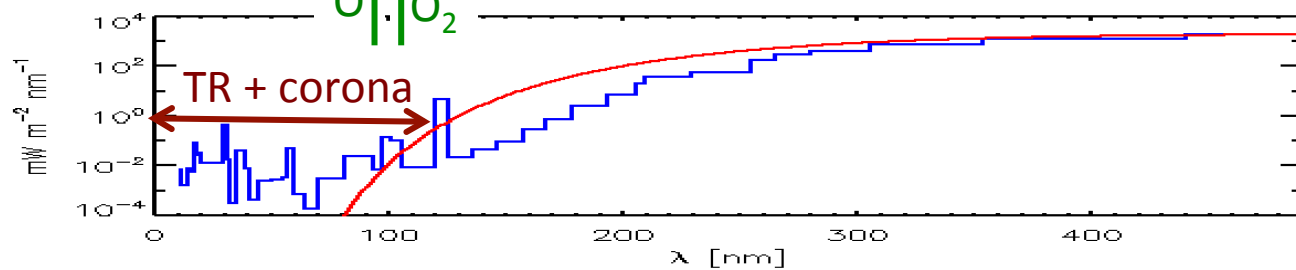
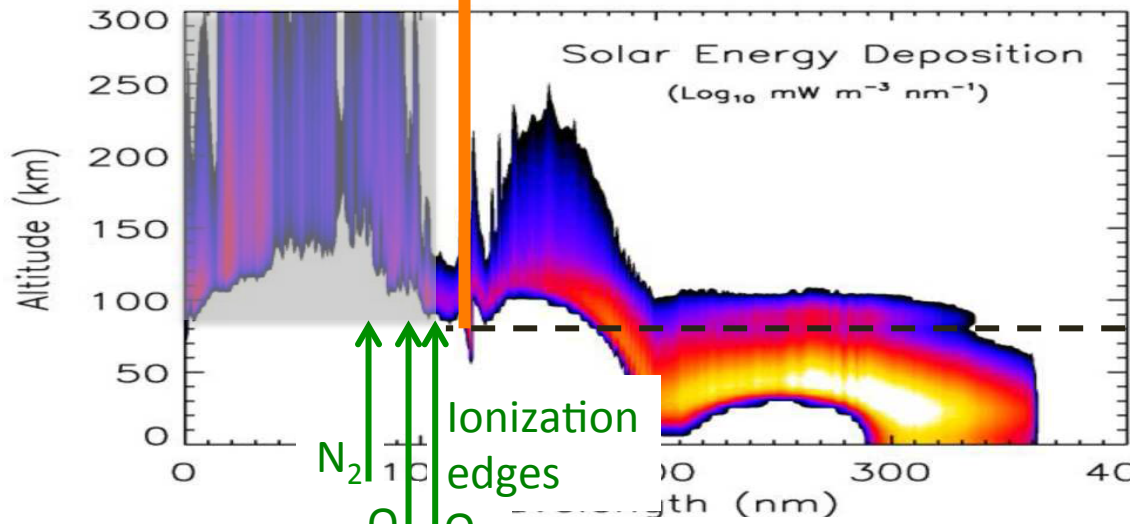
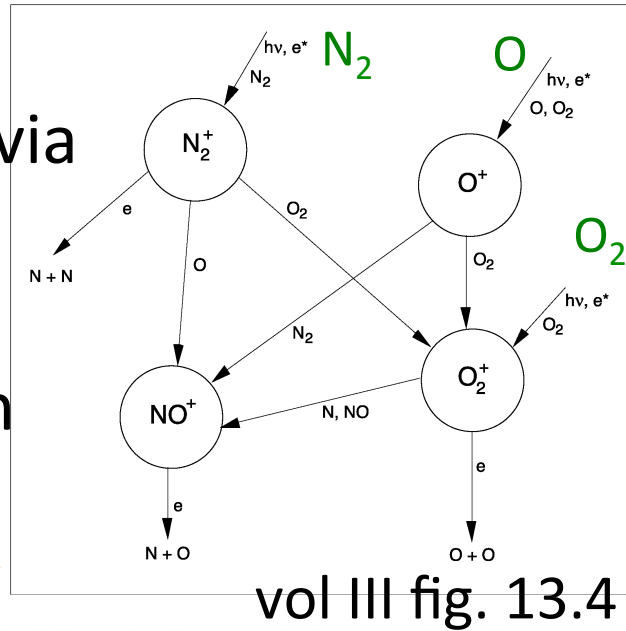

vol. III fig. 13.1

Rate of photo-ionization (per volume)

= **Electron production** rate:

$$q(z) = \sigma_{\text{ion}} n(z) F(z) = \sigma_{\text{ion}} n(z) F_{\infty} P(z)$$
$$= \sigma_{\text{ion}} n_0 F_{\infty} \exp \left[-e^{-(z-z_{\tau 1})/H} - \frac{z}{H} \right]$$

Electron destruction by recombination
with +ve ions @ rate

$$L = \alpha n_e n_i \approx \alpha n_e^2 \quad \text{Assuming neutrality}$$

Production balances
destruction: $q=L$

$$n_e(z) = \sqrt{\frac{q(z)}{\alpha(z)}}$$

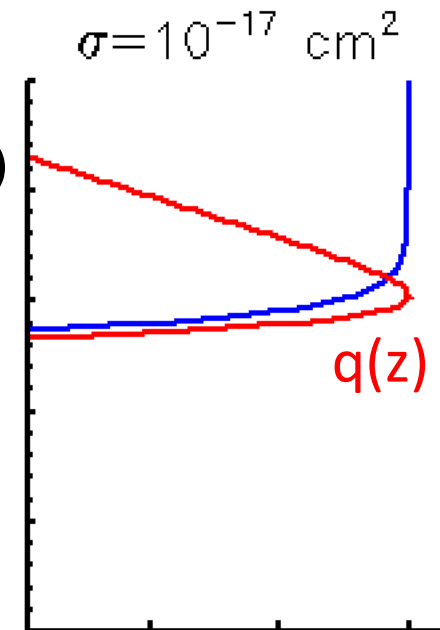

Production shut off –
recombination
removes electrons

$$\frac{dn_e}{dt} = -L \approx -\alpha n_e^2$$

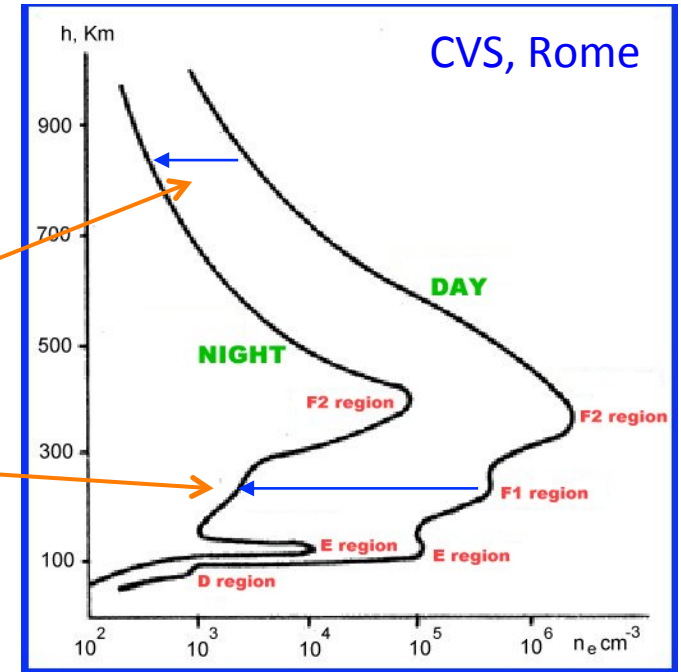

MH 20111229 Evolution of electron density profiles over time

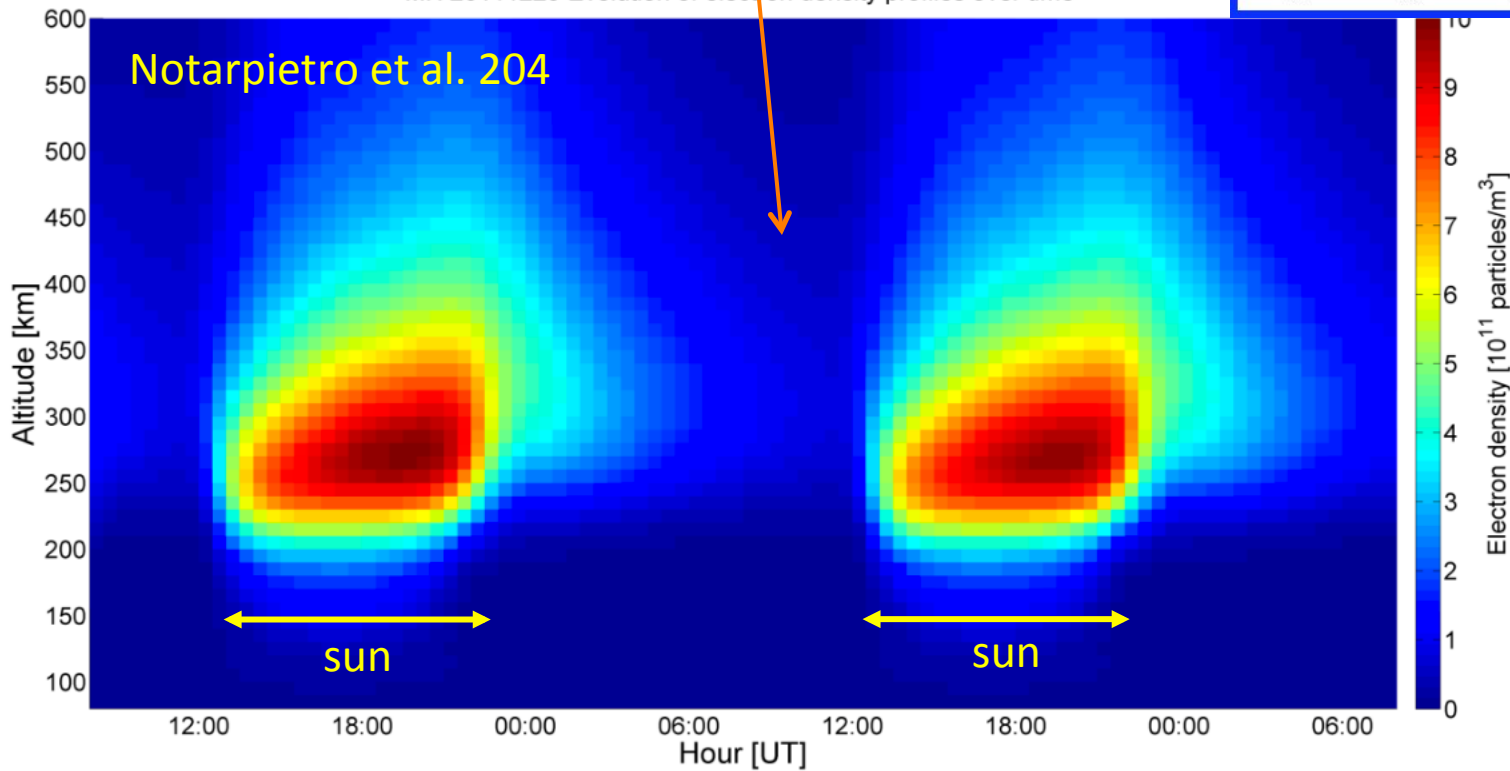

29-30-Dec-2011
Millstone Hill

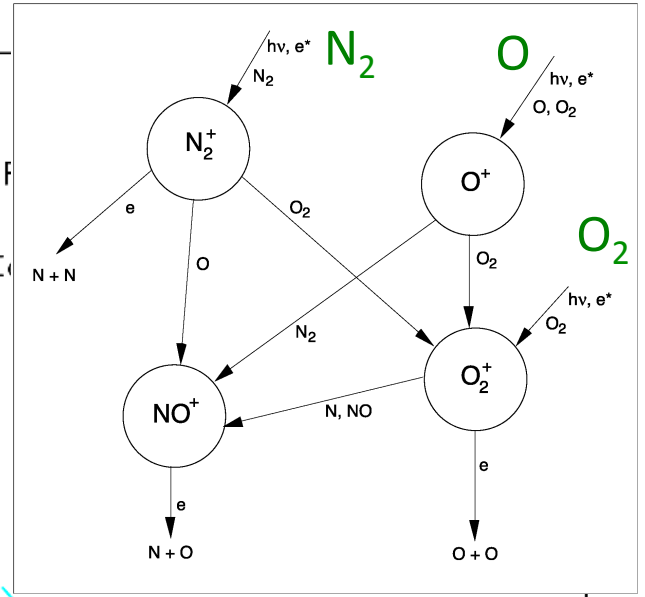
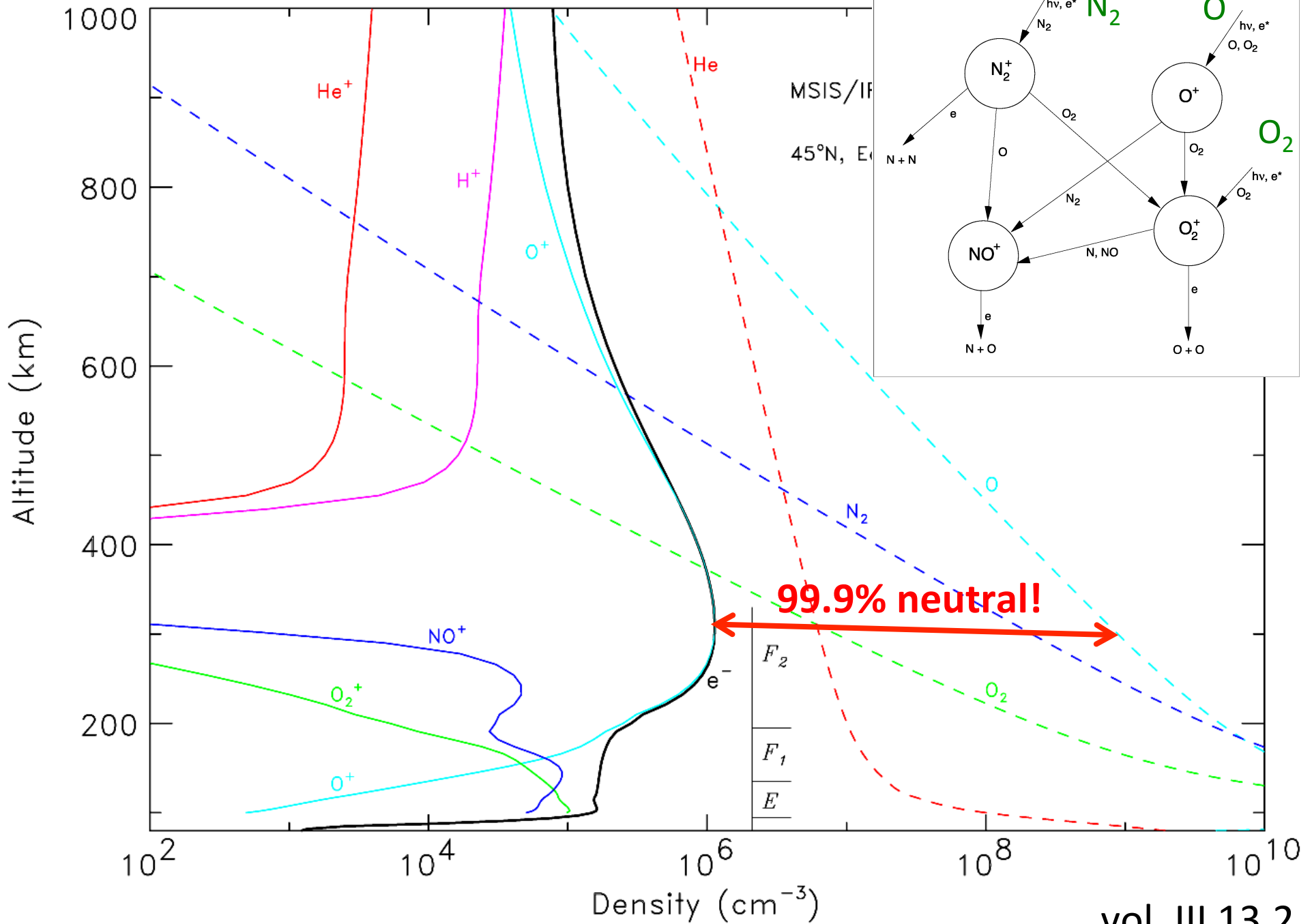

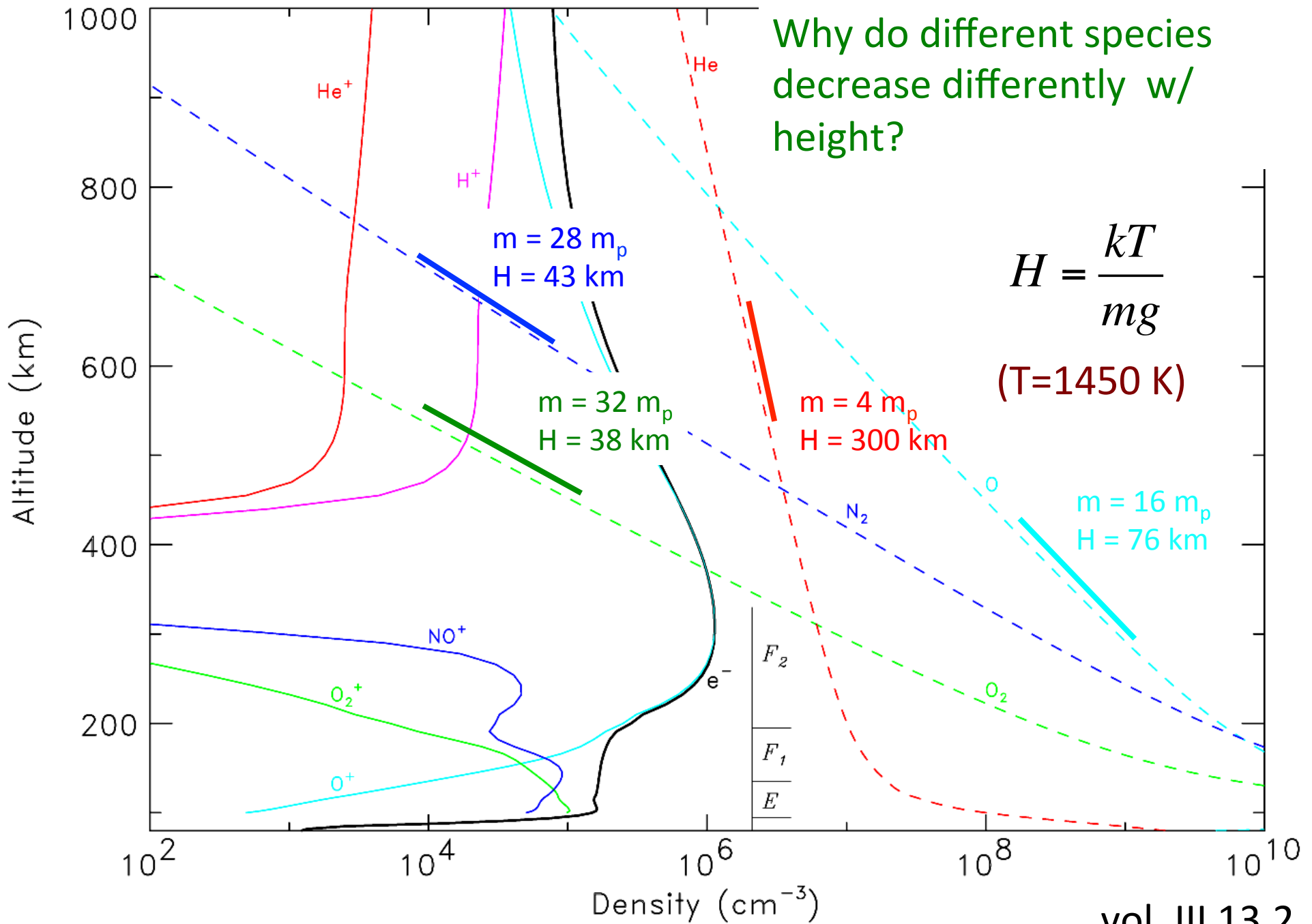

Why do different species decrease differently w/ height?

Ionospheric plasma

- ions/e⁻ form plasma – conducting fluid
- Neutrals: separate fluid
- Continual creation/destruction couples fluids
– created “drag force” between them

A plasma with electron density n_e (cm⁻³) screens out E fields w/ $f <$ its plasma frequency

$$f_p = \sqrt{\frac{e^2 n_e}{\pi m_e}} = 10^4 \text{ Hz } n_e^{1/2}$$

Q: what is the lowest freq. solar radio emission we can observe from the ground?

Corona varies – ionosphere varies

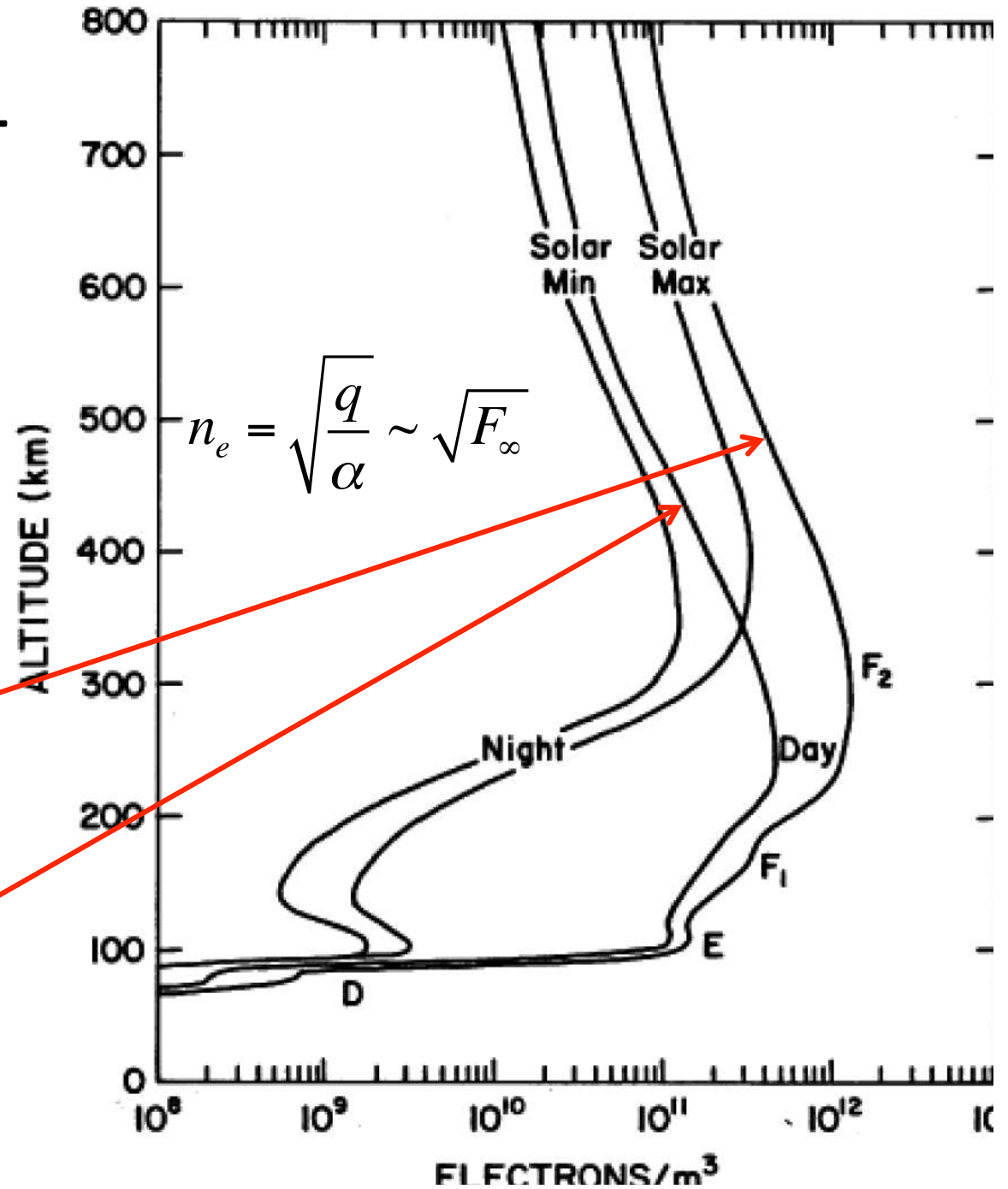
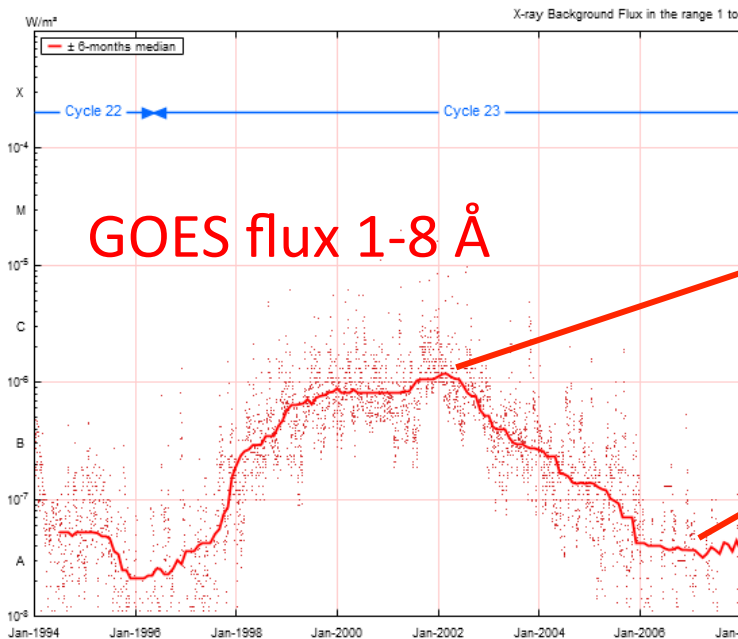

Other planets... other atmospheres

Why is Earth's
thermosphere so hot?

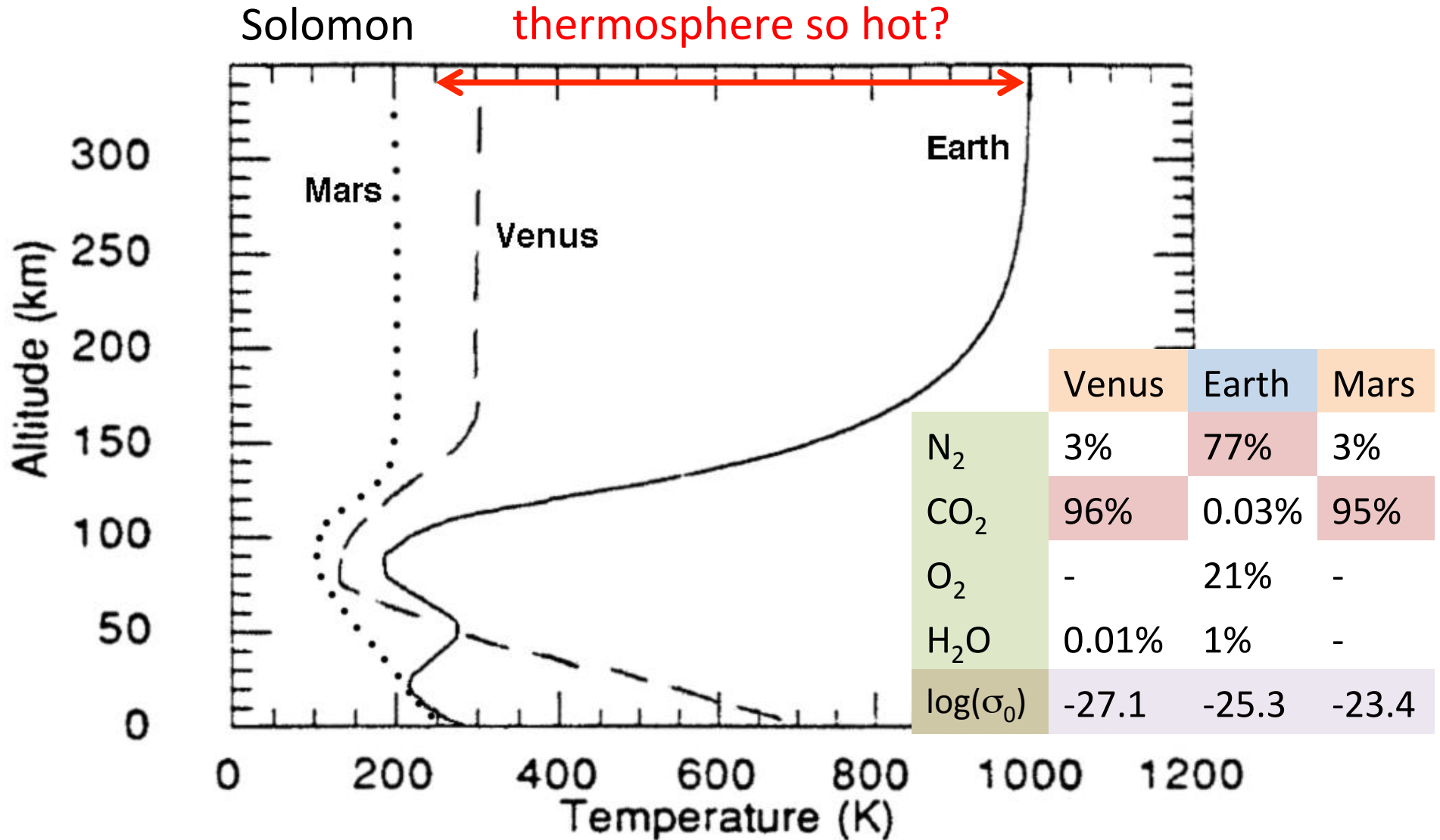

Principal Ionization Processes on Venus & Mars

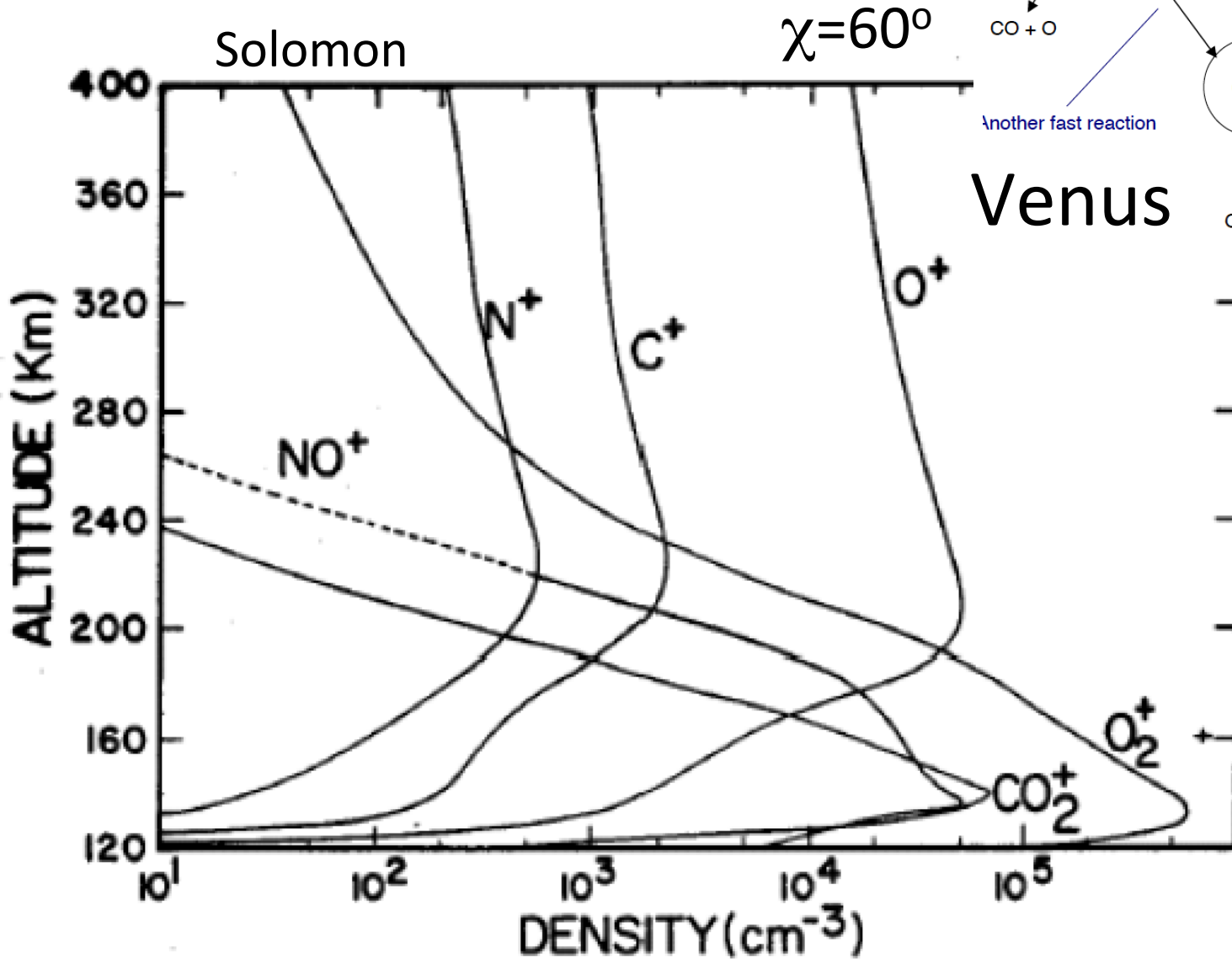
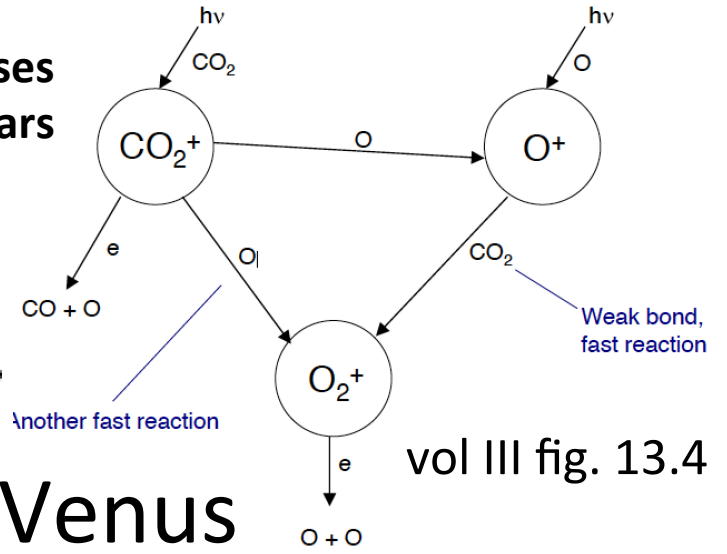

Venus	
N ₂	3%
CO ₂	96%
O ₂	-
H ₂ O	0.01%

Principal Ionization Processes
on Venus & Mars

vol III fig. 13.6

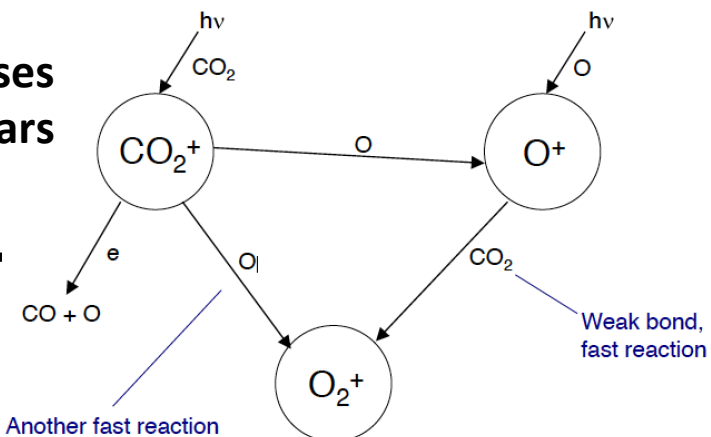
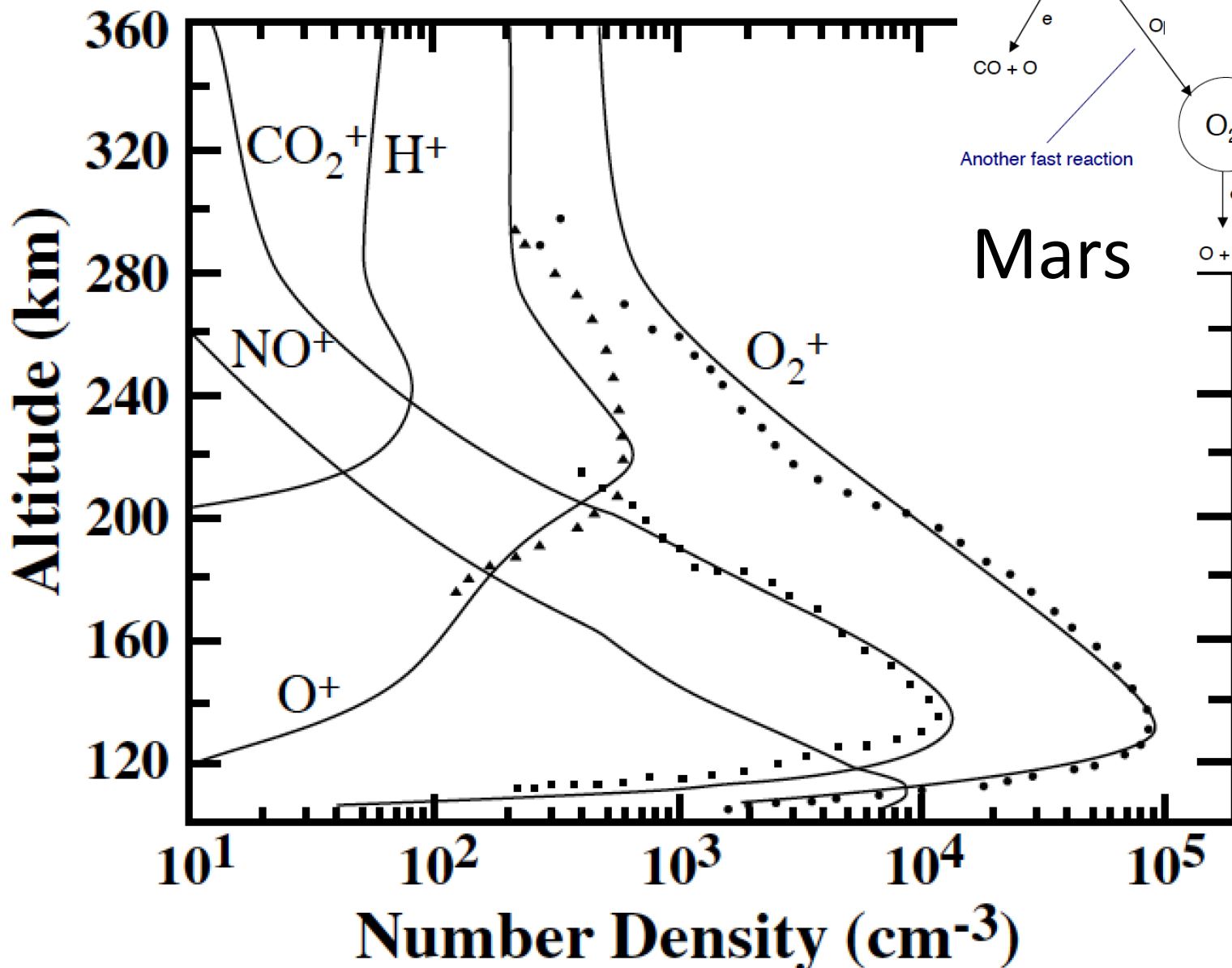

vol III fig. 13.4

Mars

Mars	
N ₂	3%
CO ₂	95%
O ₂	-
H ₂ O	-

Venus or Mars

- No dynamo – no **B**
- Ionosphere →
conducting bdry
- SW– w/ **B** – can't
penetrate
- Supersonic flow
deflected by
obstacle
- Bow shock forms

Spreiter & Stahara 1980

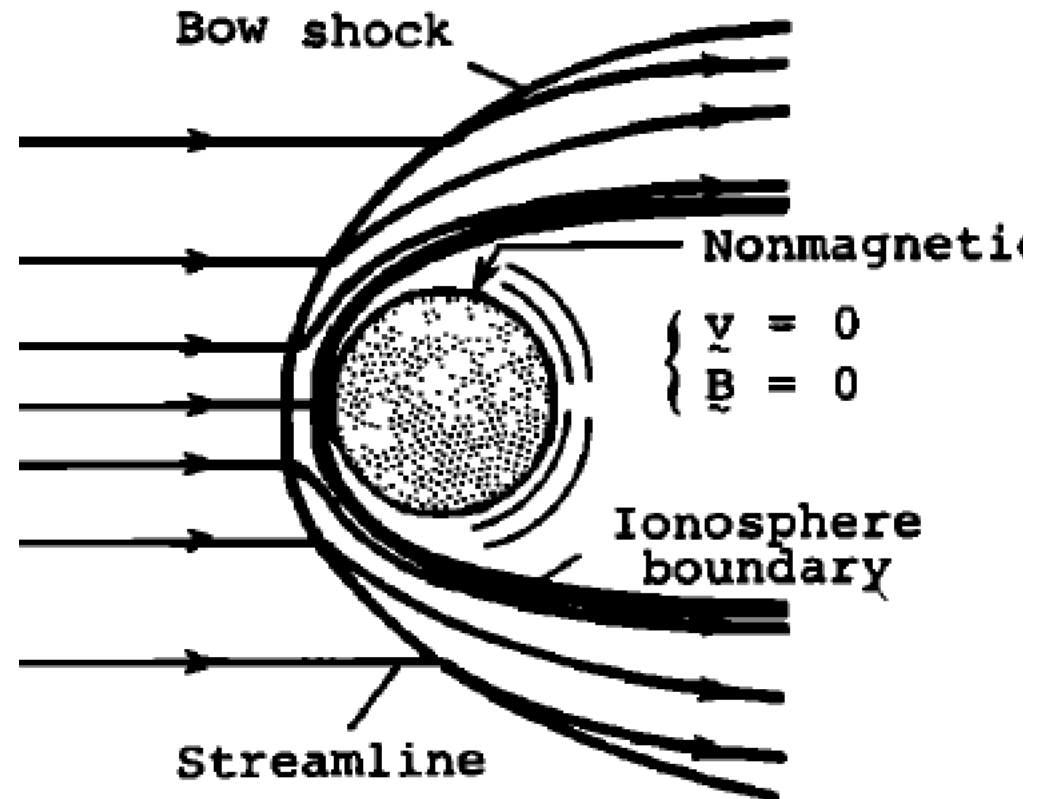

Simple picture of bow shock

- Ignore pressure from SW **B**
- SW: $u_\infty/c_{s,\infty}, \rho_\infty, M_\infty \gg 1$
- Standing shock \sim sphere radius = R_s
- Post-shock flow
 - v. ubsonic – $M \ll 1$
 - ➔ \sim incompressible w/ $u_r(R) = 0$

$$\mathbf{u} = \nabla\psi \times \nabla\phi$$

$$\psi(r, \theta) = C \left(\frac{r^4}{R^4} - \frac{R^2}{r^2} \right) \sin^2 \theta \quad \text{Lighthill 1957}$$

$$\bullet \quad u_{n,2} = u_{n,1}/4, \quad u_{t,2} = u_{t,1}$$

$$\frac{u_{r,2}}{\cos\theta} = 2 \frac{CR_s^2}{R^4} \left(1 - \frac{R^5}{R_s^5} \right) = -\frac{1}{4} u_\infty \quad \frac{u_{\theta,2}}{\sin\theta} = -\frac{CR_s^2}{R^4} \left(4 + \frac{R^5}{R_s^5} \right) = u_\infty$$

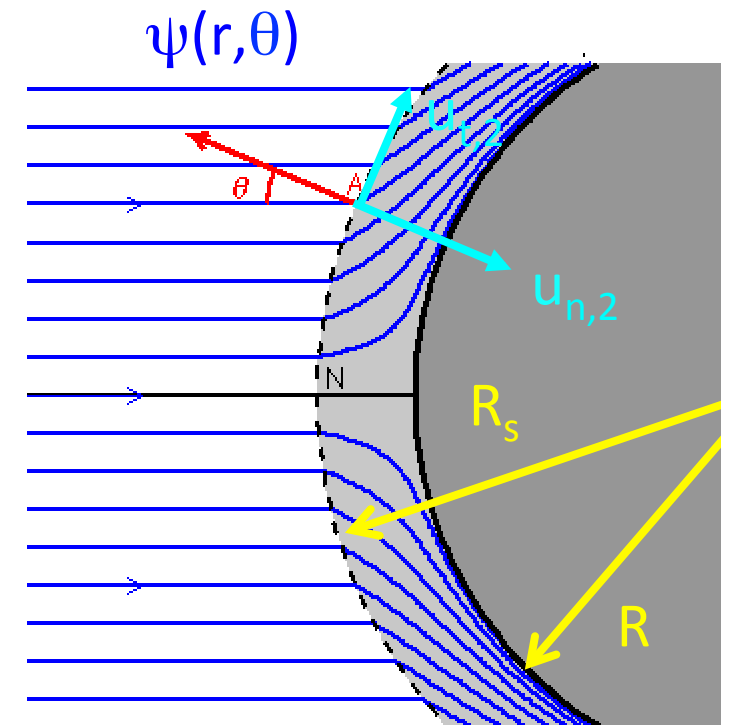

Bow
shock

$$R_s = \left(\frac{3}{2} \right)^{2/5} R = 1.18 R$$

Numerical solution
from Spreiter *et al.* 1966

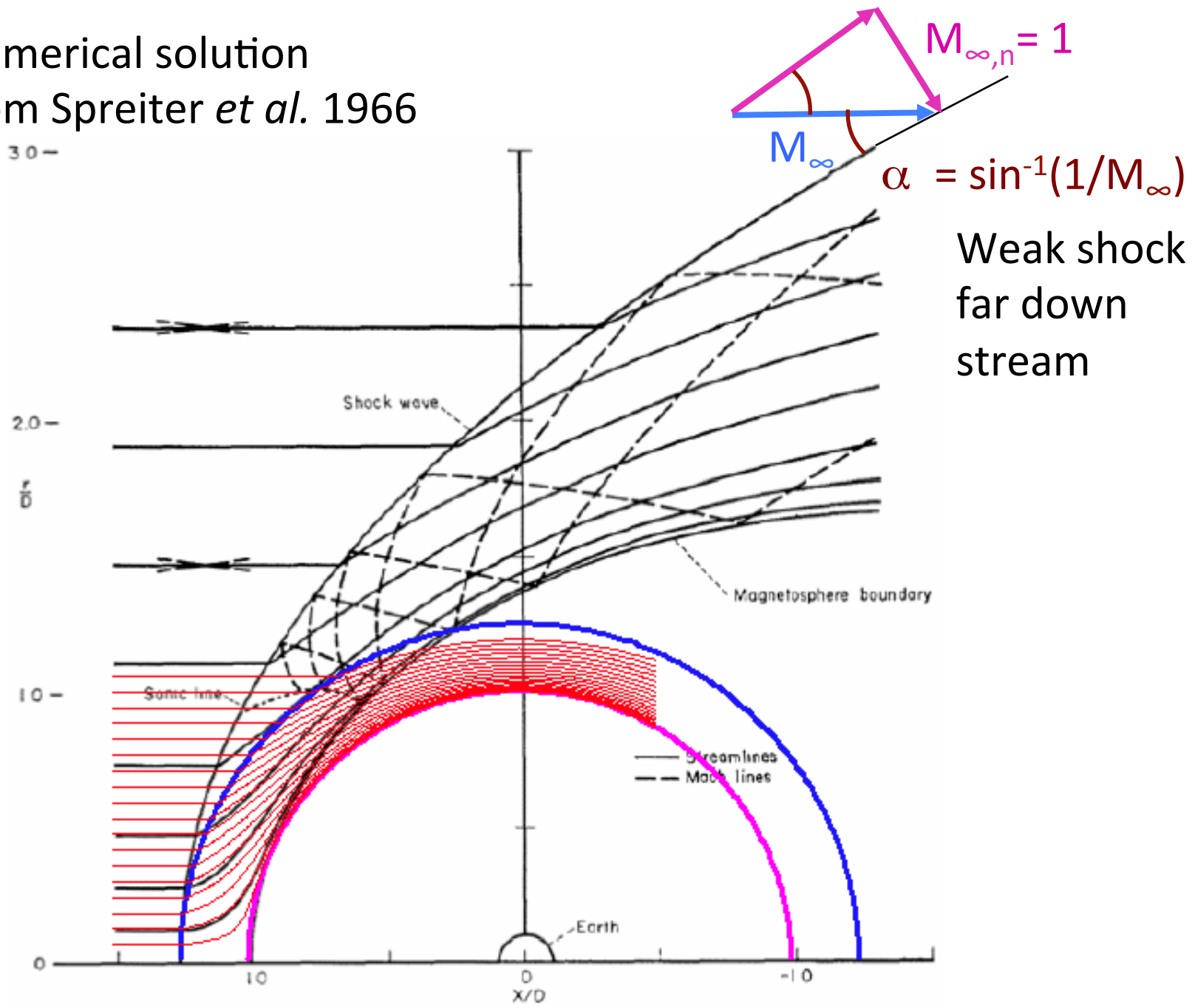

Weak shock
far down
stream

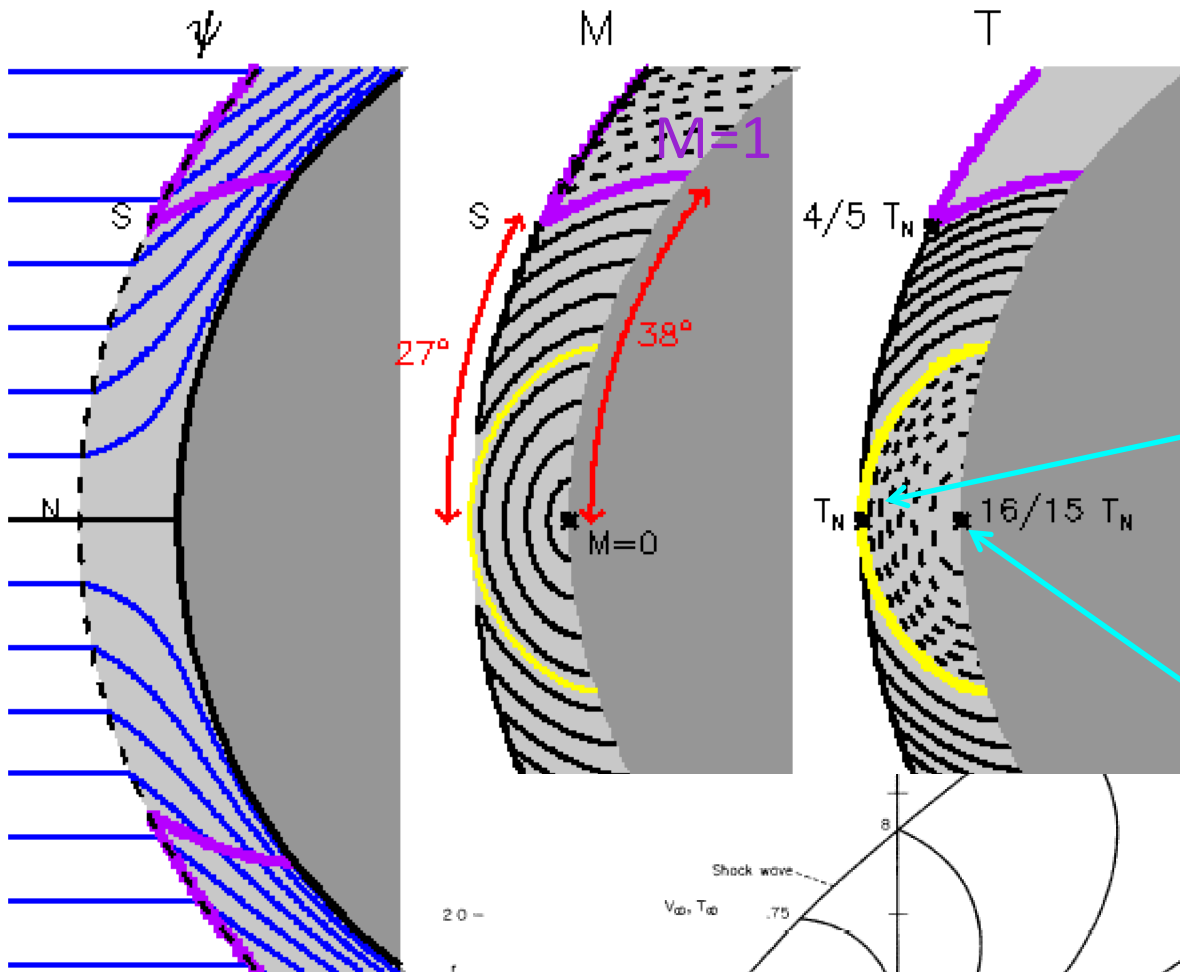

Spreiter
et al. 1966

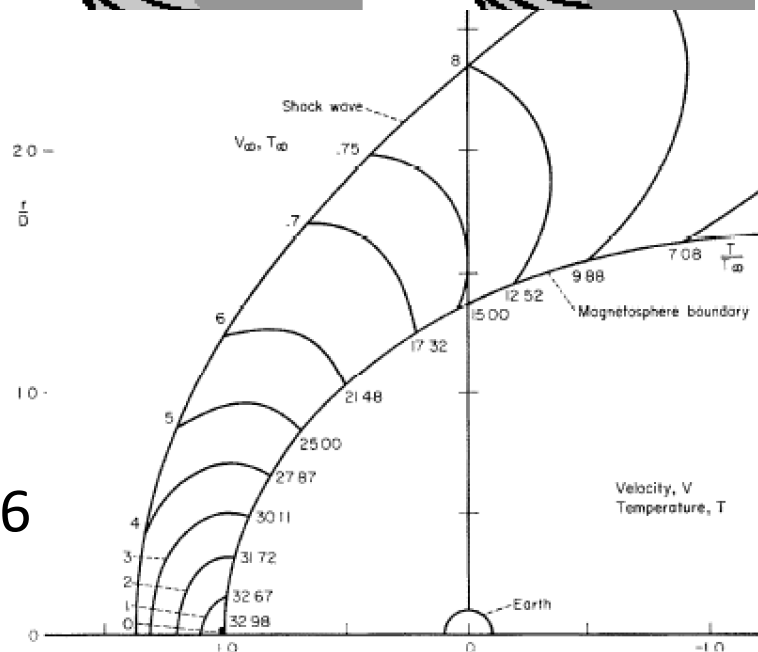

Shock **partially** therm-
alizes flow KE of SW:

- Nose point (normal)

$$T_N = \frac{3}{8} \cdot \frac{\frac{1}{2} m u_\infty^2}{k_B}$$

- Stagnation point

$$T_s = \frac{16}{15} T_N = \frac{2}{5} \cdot \frac{\frac{1}{2} m u_\infty^2}{k_B}$$

$$u_\infty = 400 \text{ km/s}$$

$$\rightarrow T_N = 3.6 \text{ MK}$$

$$\rightarrow T_s = 3.8 \text{ MK}$$

- pressure

$$p_s = \frac{4}{5} \rho_\infty u_\infty^2$$

vol. I fig. 13.13

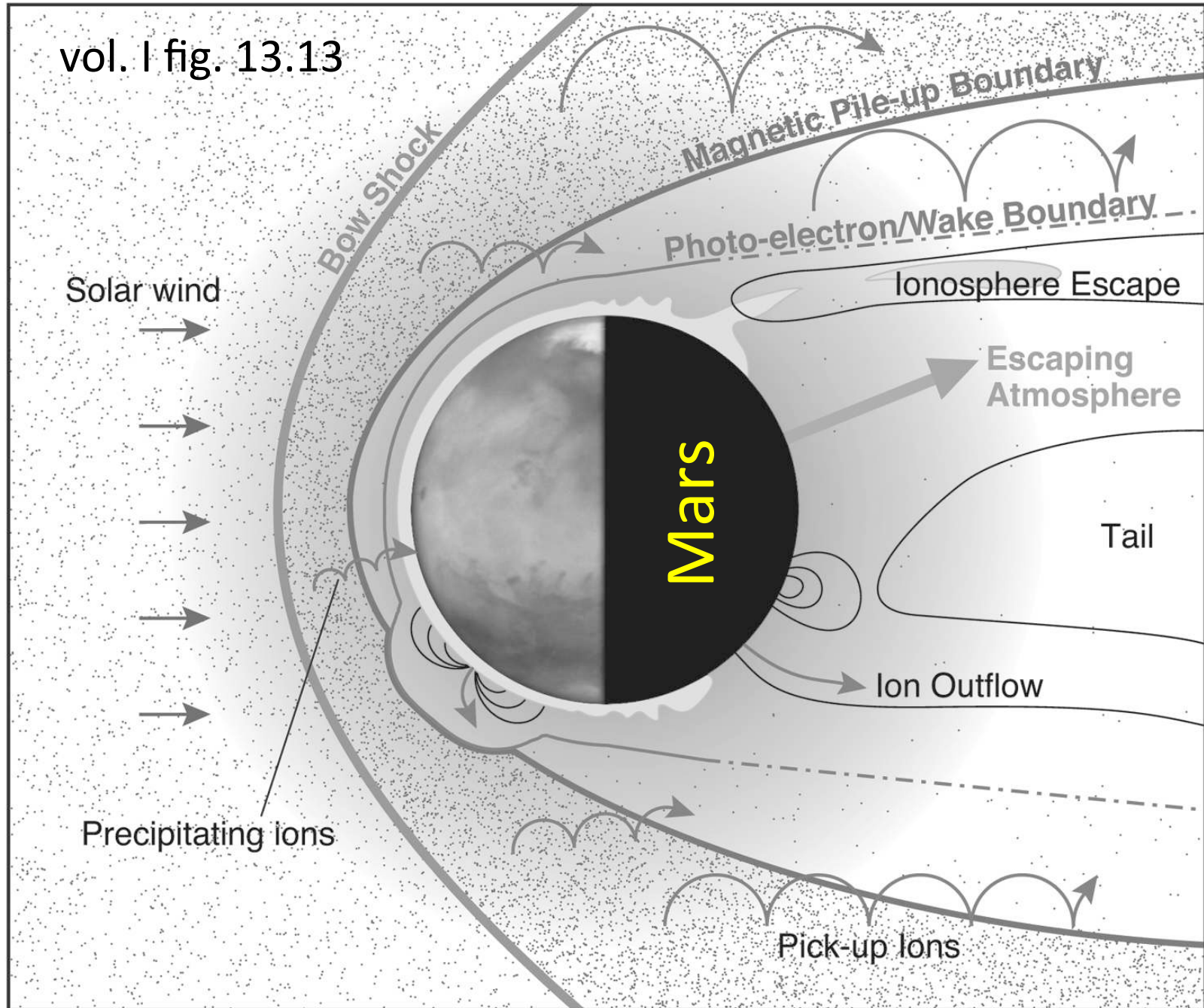

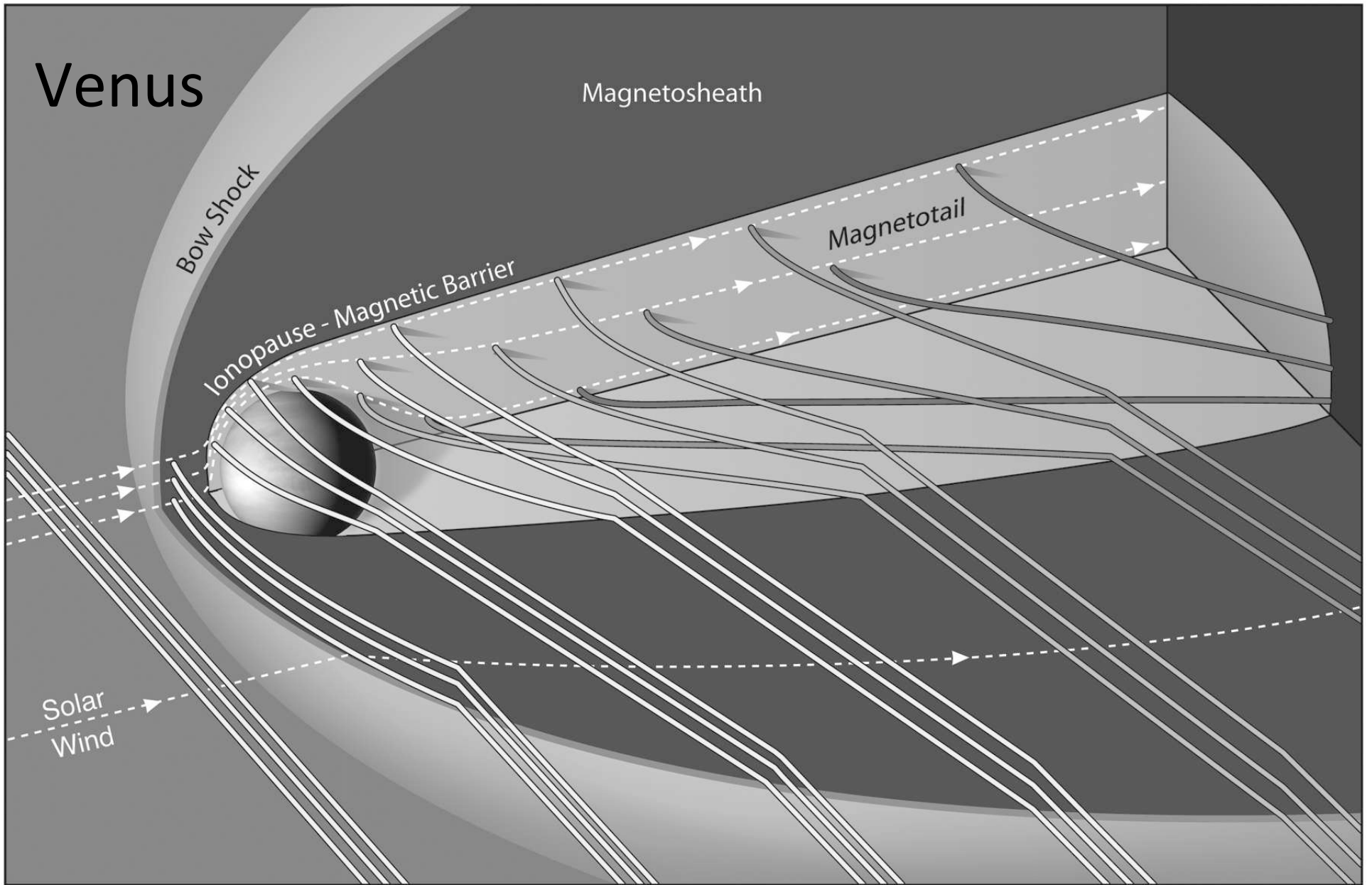

vol. I fig. 13.12

Wind @ Magnetized Planets

Earth, Jupiter, Saturn, ...

- Planetary **B** prevents SW from reaching ionosphere
- SW deflected by **magnetosphere**
- “squishy” obstacle

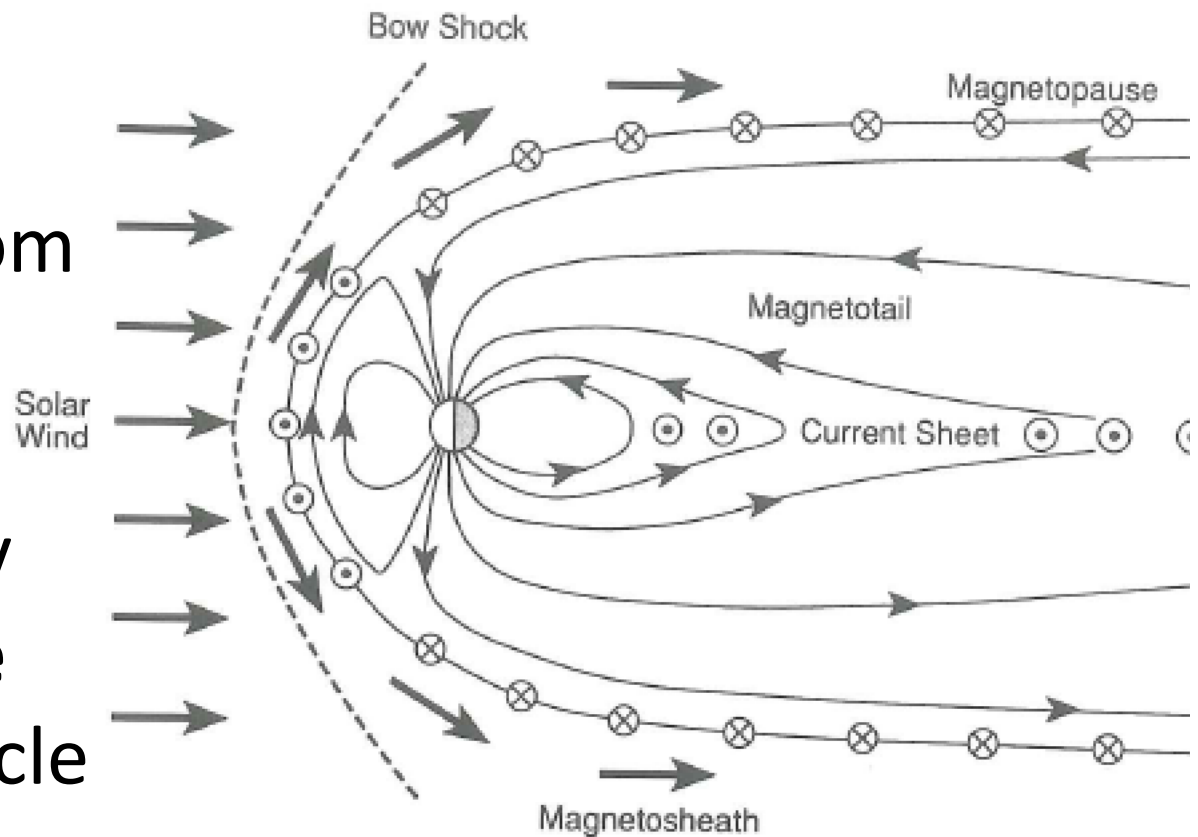

Hughes (*cf.* vol. I fig. 10.1)

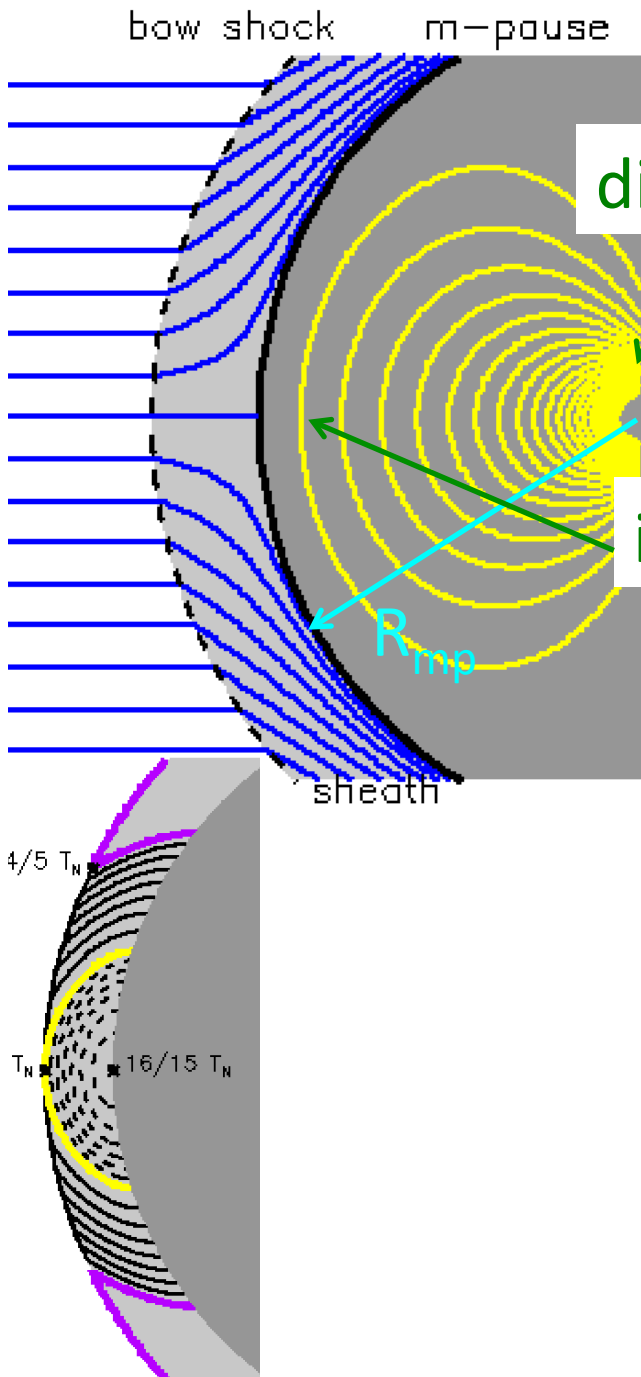

Shock & sheath: similar to before

- Stagnation point (SP) @ $r=R_{mp}$
- Plasma pressure: $p_s = \frac{4}{5} \rho_\infty u_\infty^2$
- Inside ($r < R_{mp}$): $\mathbf{B} = -\nabla\chi$

$$\chi(r, \theta) = \frac{B_\oplus R_\oplus^3}{R_{mp}^2} \left(\frac{R_{mp}^2}{r^2} + \frac{2r}{R_{mp}} \right) \cos\theta$$

- Magnetic pressure @ SP

$$\frac{1}{8\pi} |\mathbf{B}(R_{mp}, 0)|^2 = \frac{1}{8\pi} \left(\frac{1}{R_{mp}} \frac{\partial\chi}{\partial\theta} \right)^2 = \frac{9R_\oplus^6}{8\pi R_{mp}^6} B_\oplus^2$$

- Ignore inner plasma – balance

$$R_{mp} = \left(\frac{45}{32\pi} \right)^{1/6} \left(\frac{B_\oplus^2}{\rho_\infty u_\infty^2} \right)^{1/6} R_\oplus$$

Chapman-Ferraro Distance

Intuition break

$$R_{mp} = \left(\frac{45}{32\pi} \right)^{1/6} \left(\frac{B_{\oplus}^2}{\rho_{\infty} u_{\infty}^2} \right)^{1/6} R_{\oplus} \sim 12 R_{\oplus}$$

$$\rho_{sw} = 10^{-23} \text{ g/cm}^3$$
$$u_{sw} = 400 \text{ km/s}$$

- At what distance do geostationary satellites orbit?
- Is the moon inside or outside the magnetopause?
- What happens to R_{mp} during fast SW: $u_{sw} = 800 \text{ km/s}$

Similar picture from high-powered codes

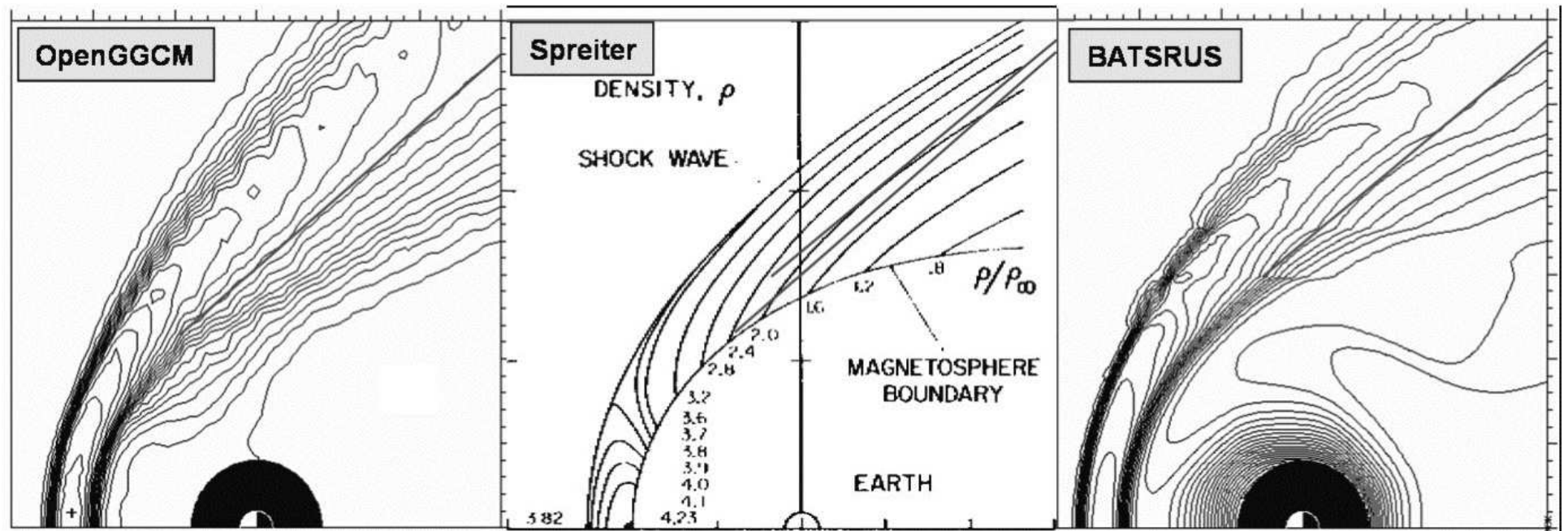

vol. I fig. 11.2

Other planets... same story

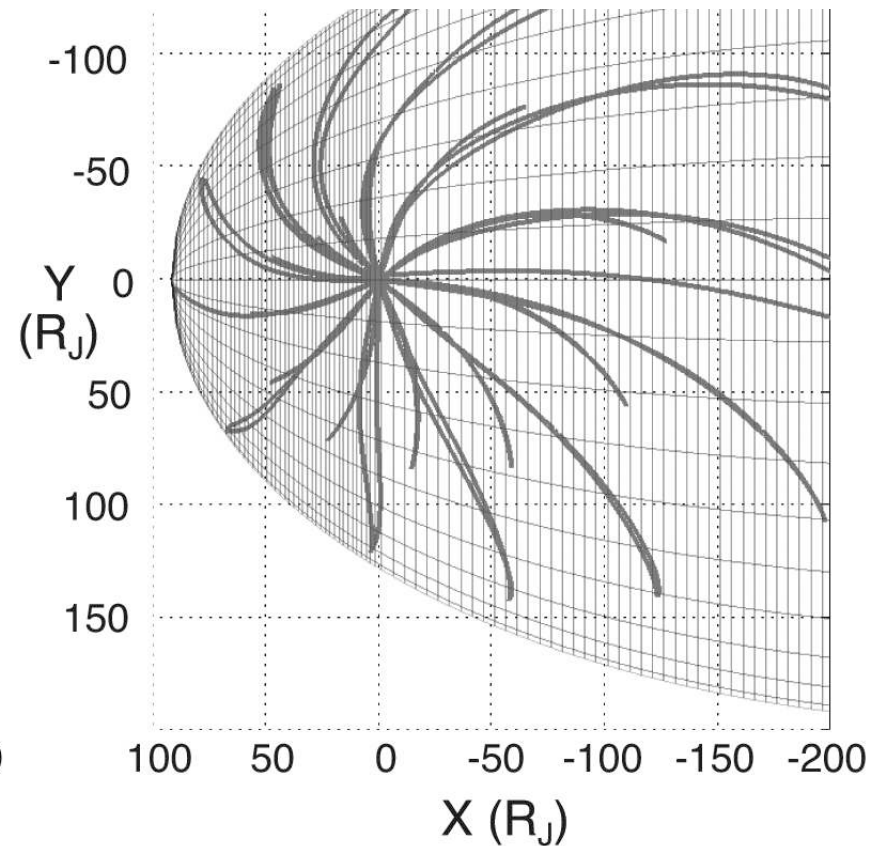
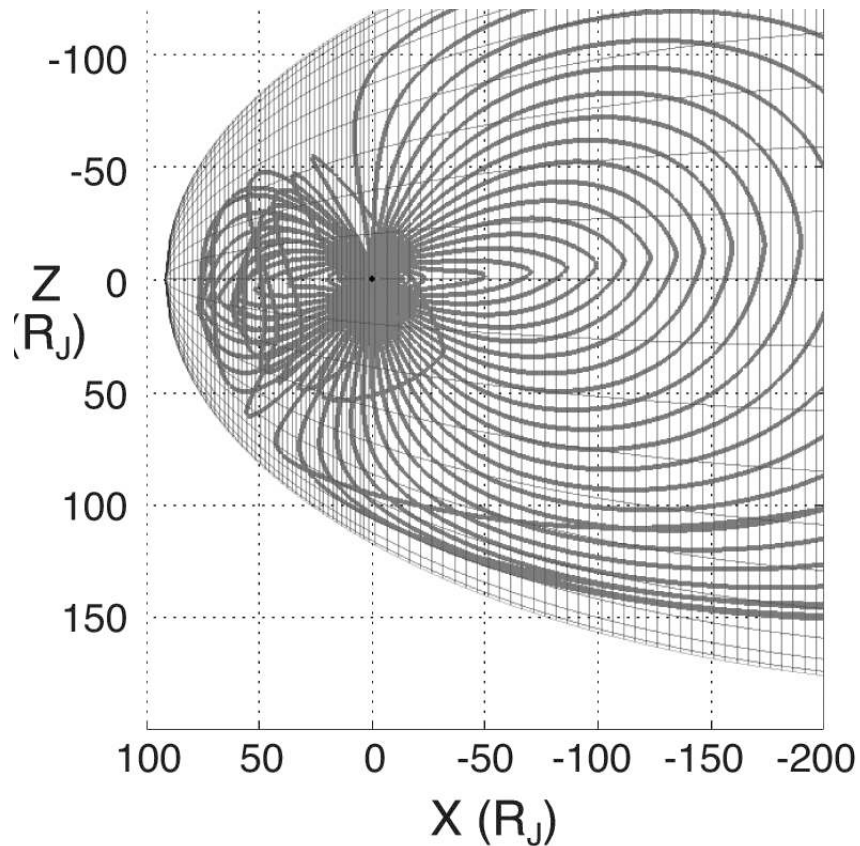

vol. I fig. 13.6

$$B_J \sim 15 B_{\oplus} \sim 5 \text{ G}; \quad \rho_{\infty} \sim 0.04 \rho_{\infty, \oplus}$$

→ Jupiter's magnetopause:

$$R_{mp,J} \sim 50 R_J = 3.5 \times 10^{11} \text{ cm}$$

But not all of Earth's field stays confined to m-sphere

Reconnection with SW field
(consider southward IMF)

- Creates “open” flux connected to poles @ $\dot{\Phi}_{ds}$
- SW sweeps flux downstream – into **magnetotail**
- Steady state only when reconnection in tail “closes” flux at rate $\dot{\Phi}_n = -\dot{\Phi}_{ds}$
- Requires long & strong **neutral sheet** in magnetotail

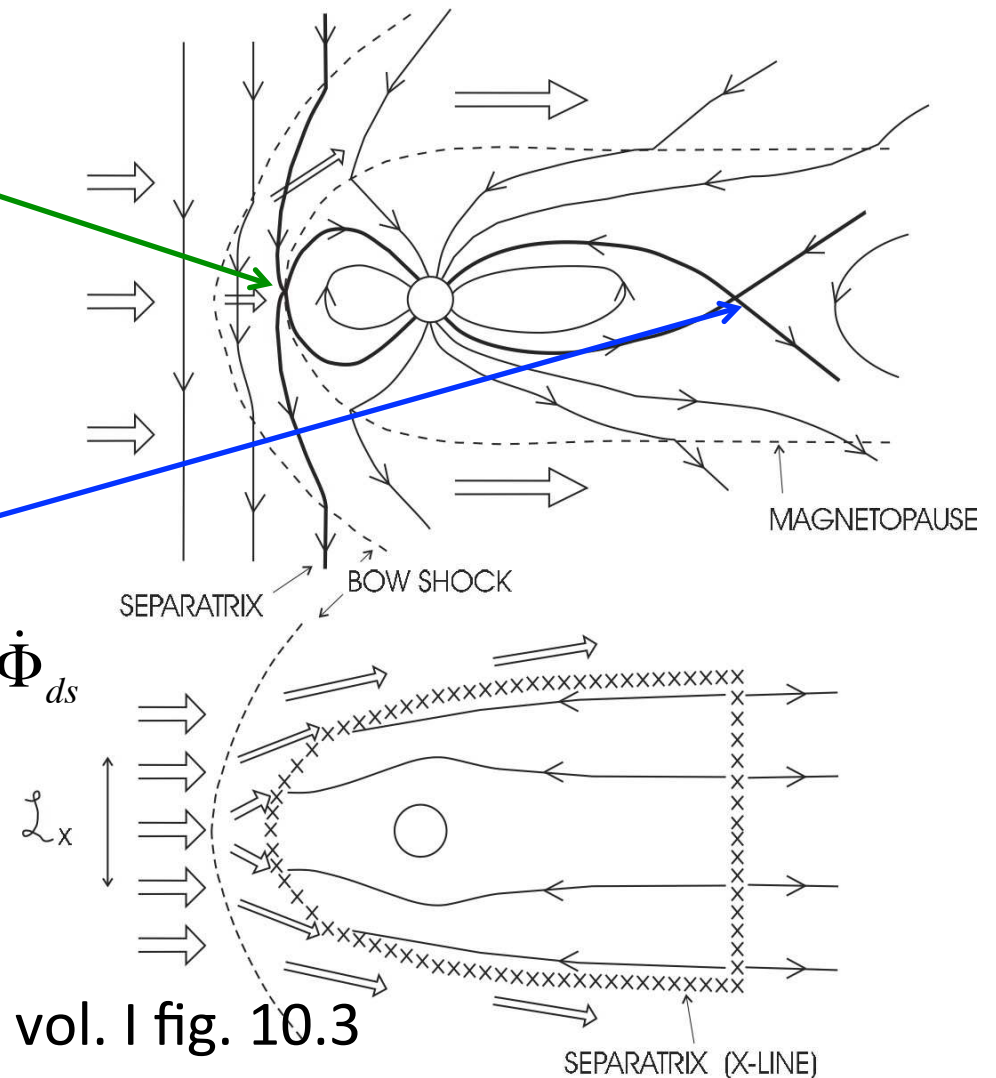

But not all of Earth's field stays confined to m-sphere

Hughes (cf. vol. I fig. 6.3)

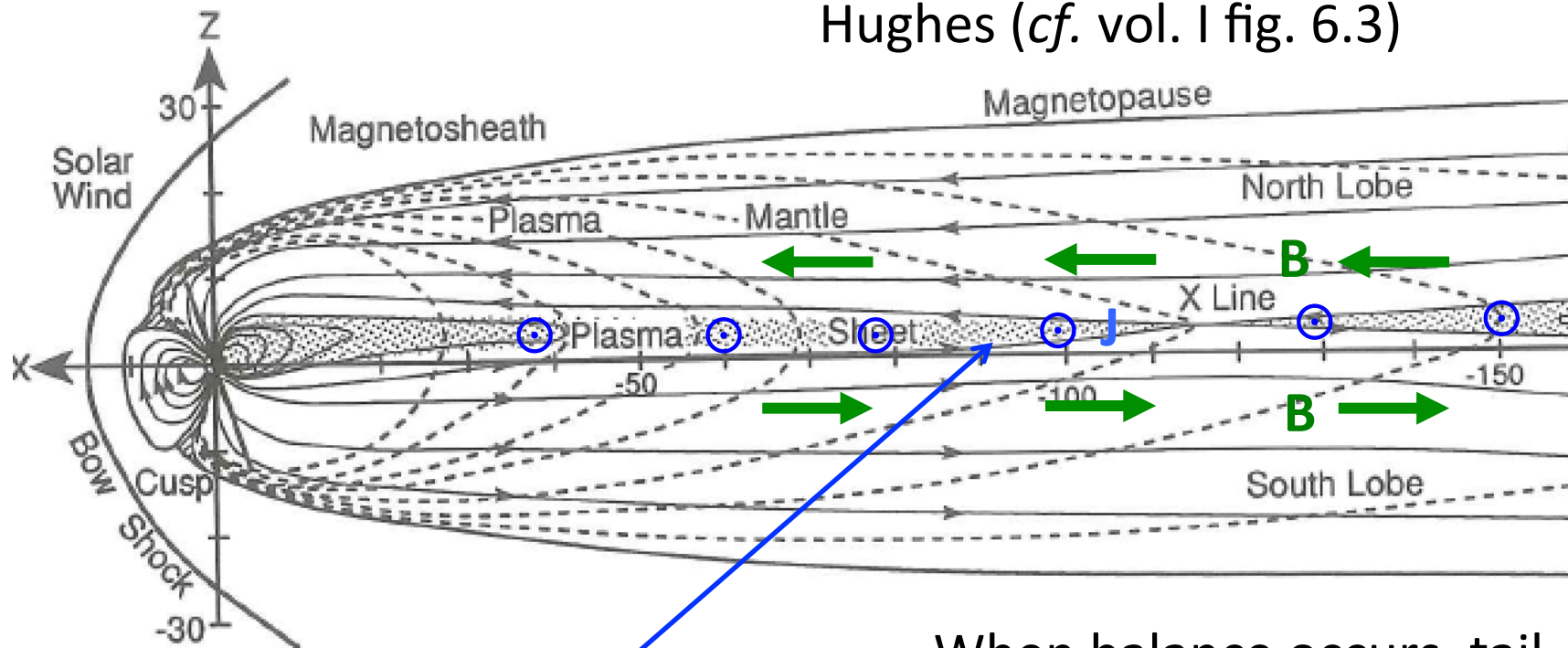

“closes” flux at rate $\dot{\Phi}_n = -\dot{\Phi}_{ds}$

- Requires long & strong **neutral sheet** in magnetotail

When balance occurs, tail...

- ... has some length
- ... has some open flux

$$\Phi_t$$

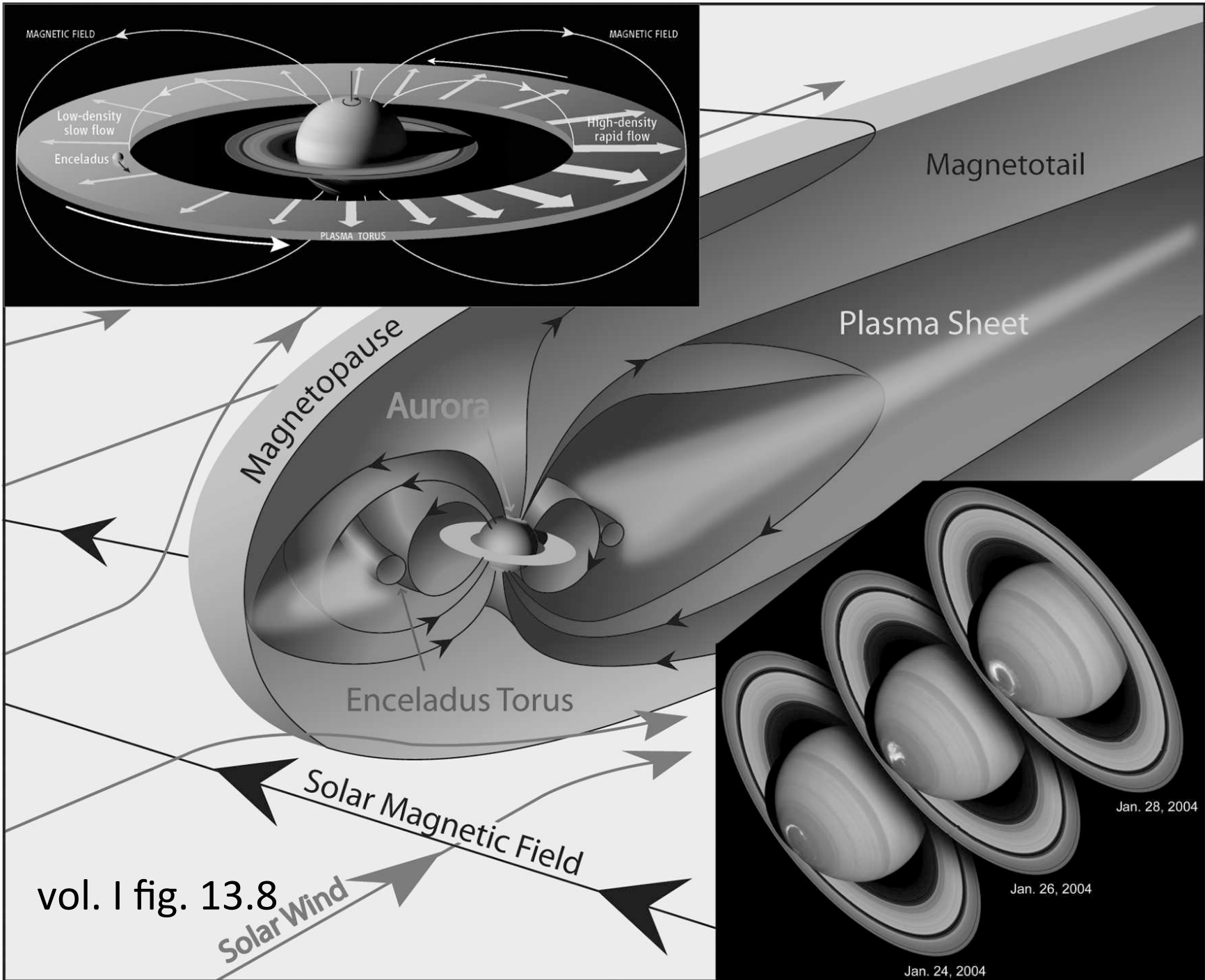

NEPTUNE

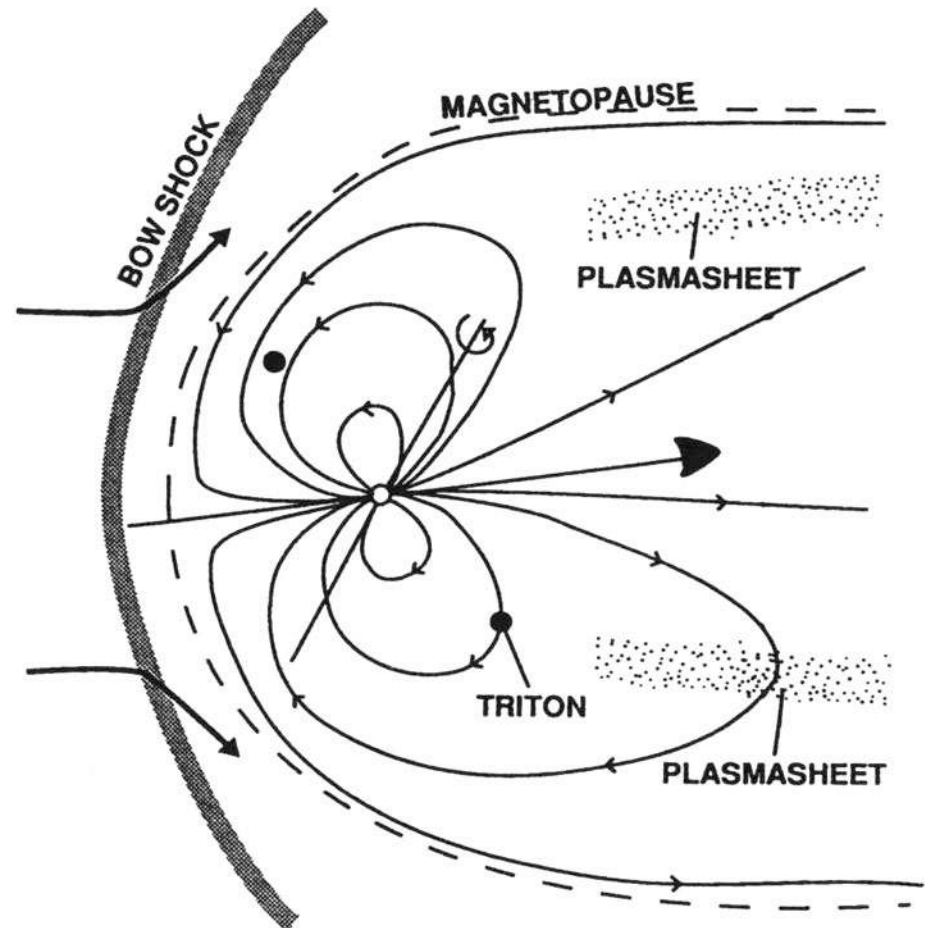
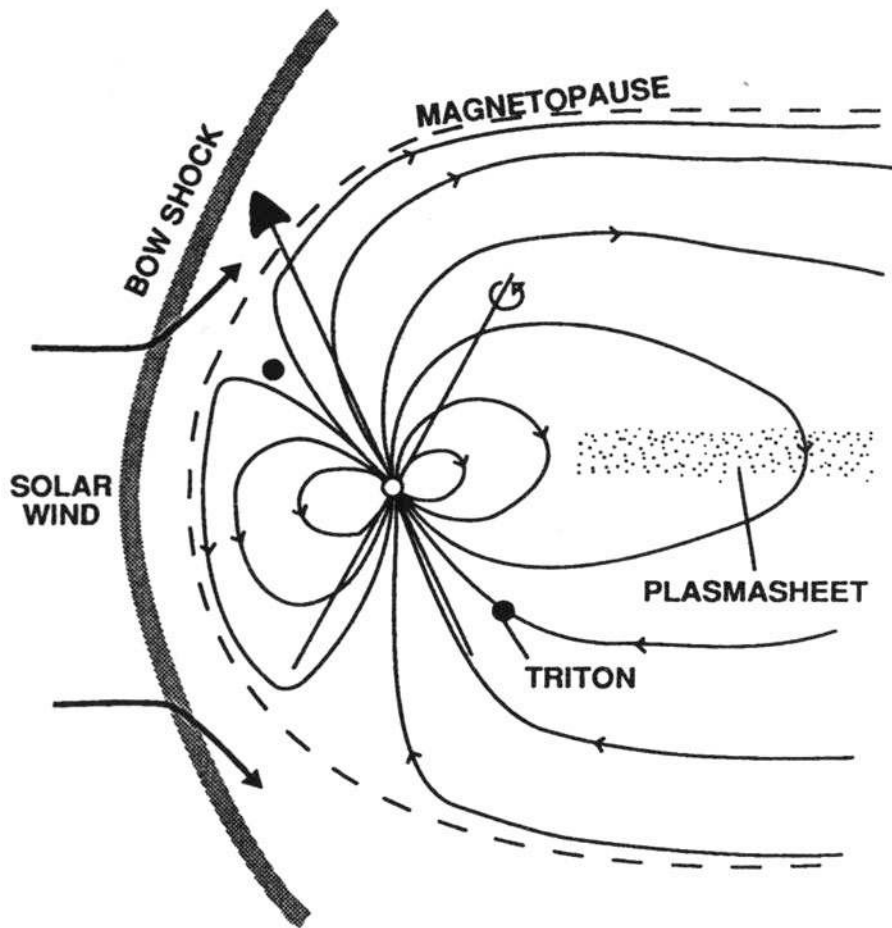

vol. I fig. 13.10

closed/open boundary maps down to
“auroral oval”

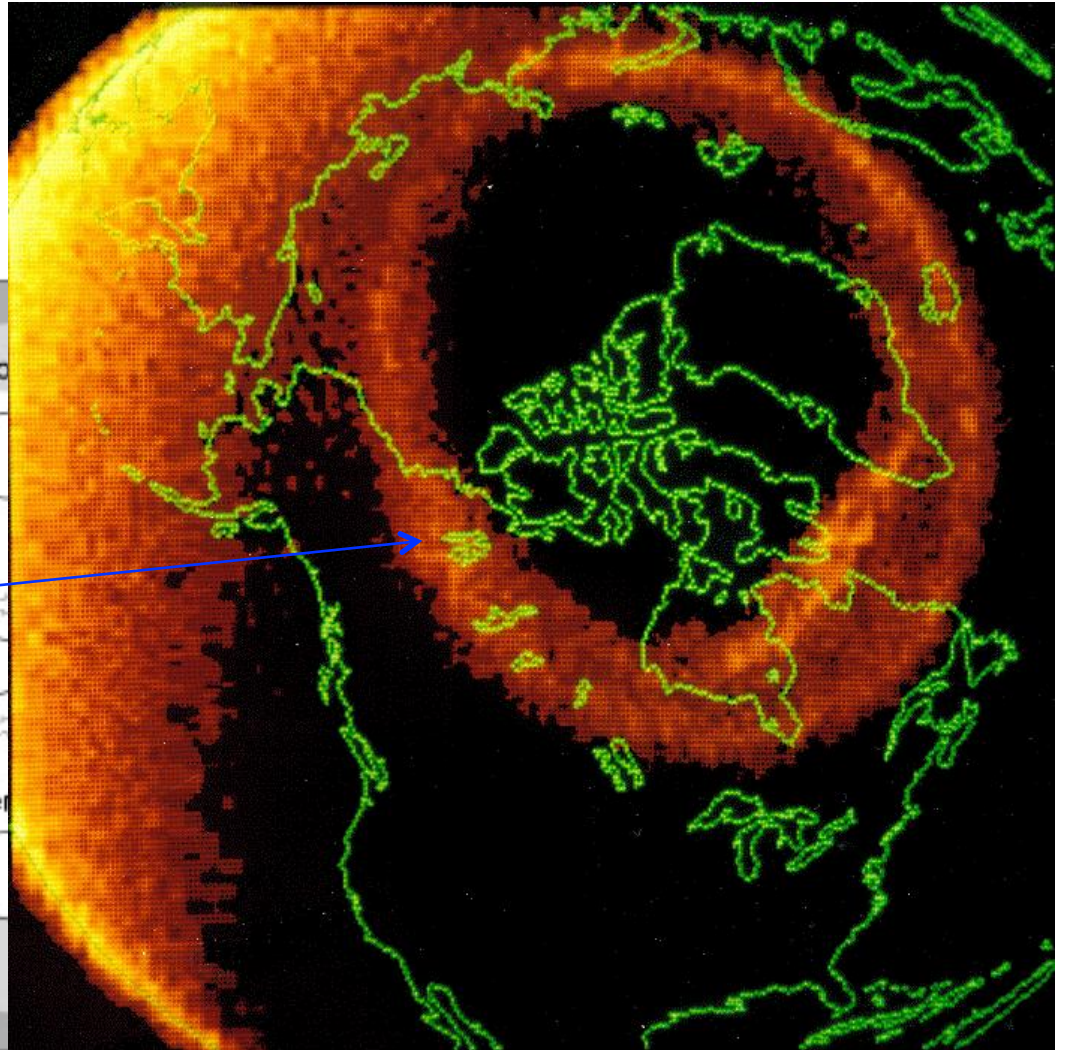
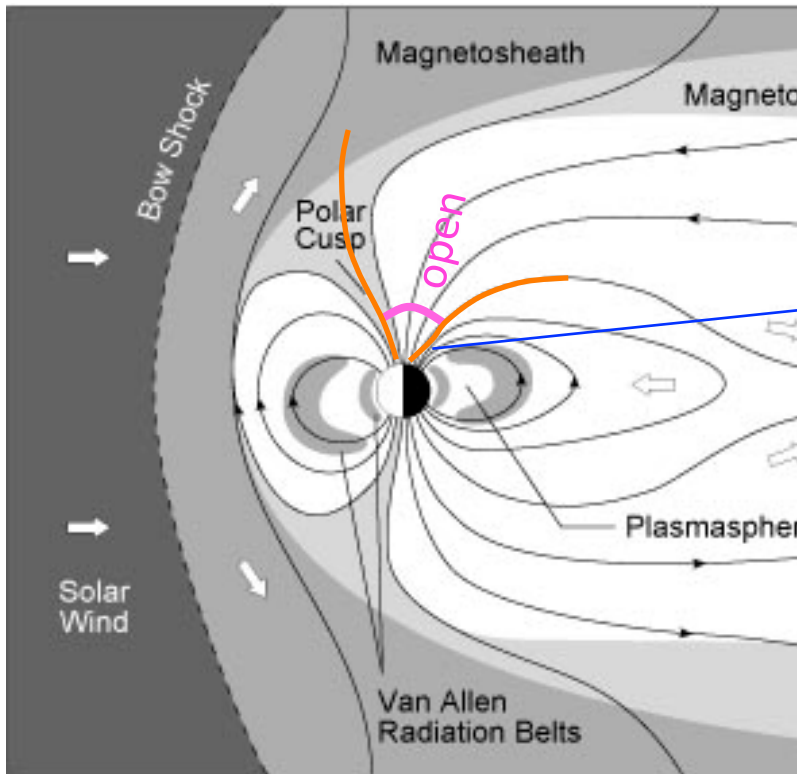

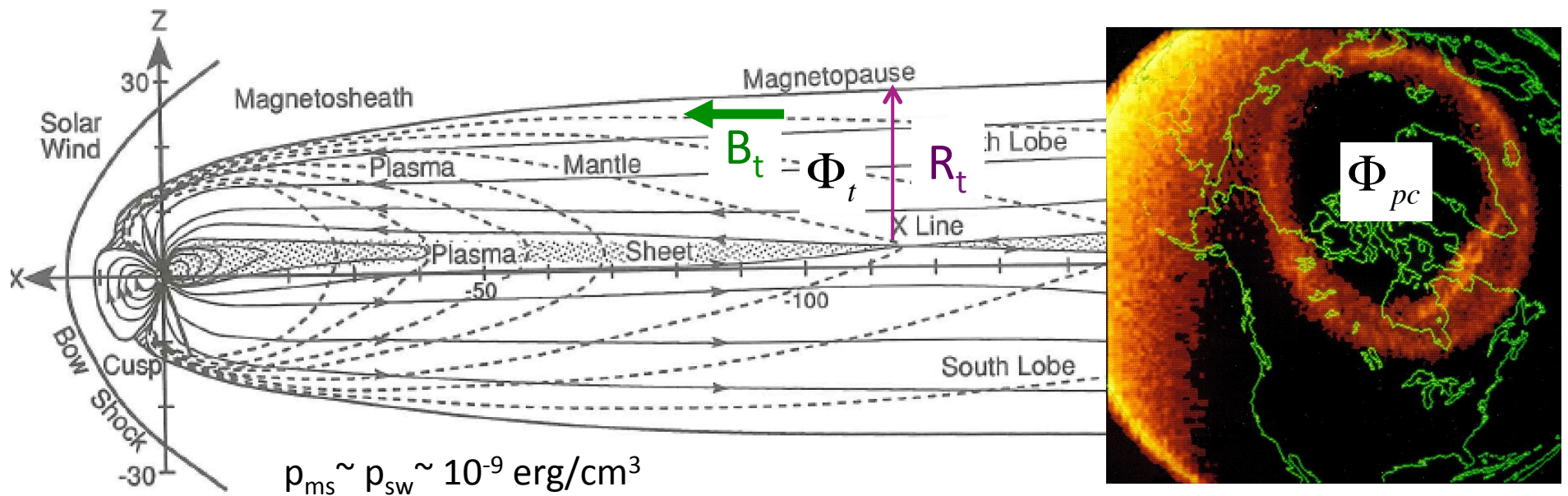

$$\Phi_t = \Phi_{pc} = \pi \left(R_{\oplus} \sin \theta_{pc} \right)^2 B_{np} \sim \pi R_{\oplus}^2 \theta_{pc}^2 B_{np} \sim 10^{17} \text{ Mx}$$

$$\Phi_t = \frac{\pi}{2} R_t^2 B_t \quad \text{mag. pressure} \quad \frac{1}{8\pi} B_t^2 = \frac{1}{2\pi^3} \frac{\Phi_t^2}{R_t^4} = \frac{1}{2\pi} \left(\frac{R_{\oplus}}{R_t} \right)^4 \theta_{pc}^4 B_{np}^2$$

In tail:

Pressure balance
@ m-pause:

$$\frac{R_t}{R_{\oplus}} = (2\pi)^{-1/4} \frac{B_{np}^{1/2}}{\rho_{sw}^{1/4}} \theta_{pc} \sim 25$$

$$B_t \sim 10^{-4} \text{ G} \sim 10 \text{ nT}$$

Other auroral ovals

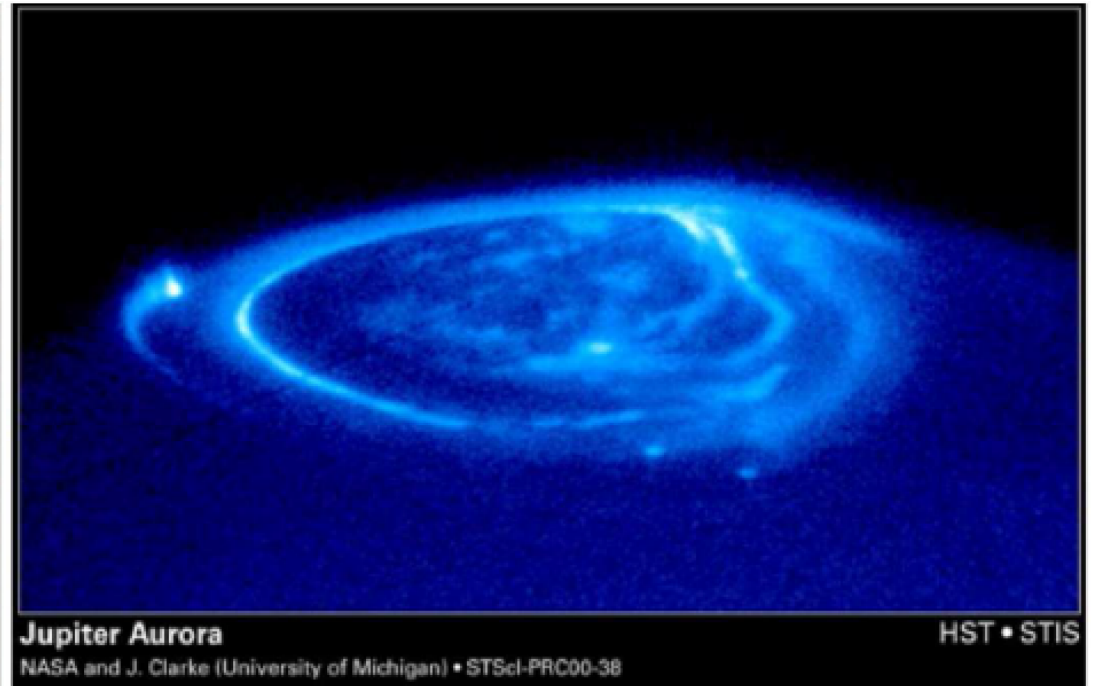

vol. I fig. 2.9

Convection: magnetosphere meets ionosphere

field lines are frozen to M-spheric plasma.
motion sweeps field lines back

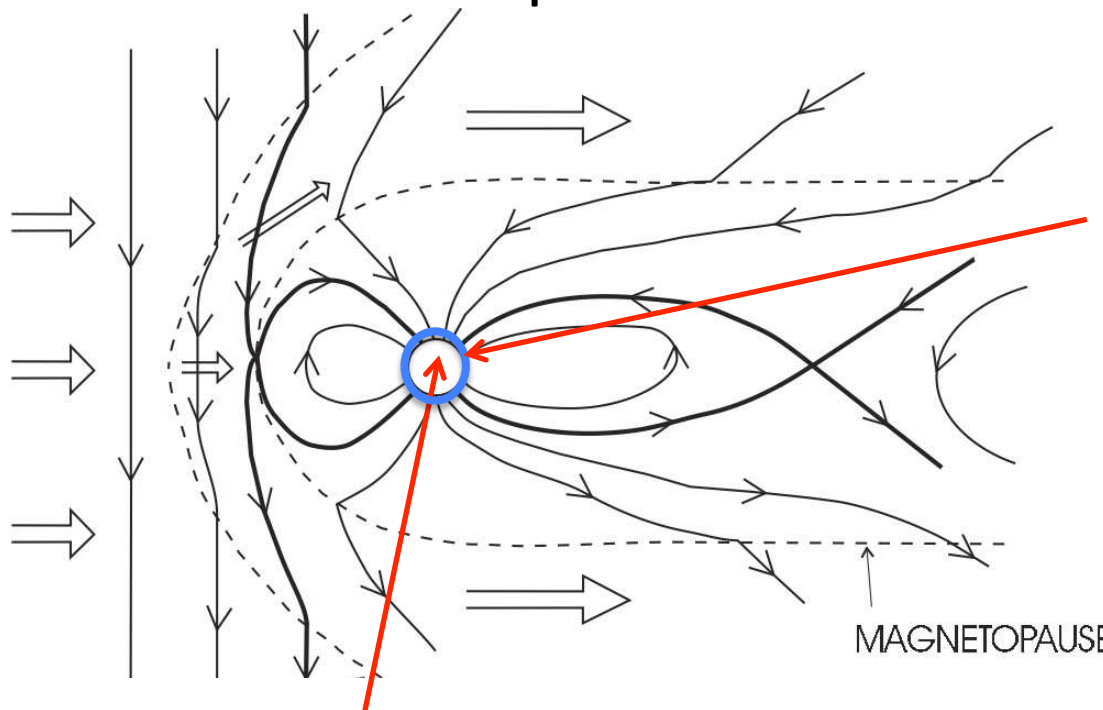

BUT: atmosphere
& solid crust are
insulators – field
lines are
imaginary there

Objection: field lines are also frozen into
liquid core – ends cannot be moved

Example of how the motions meet

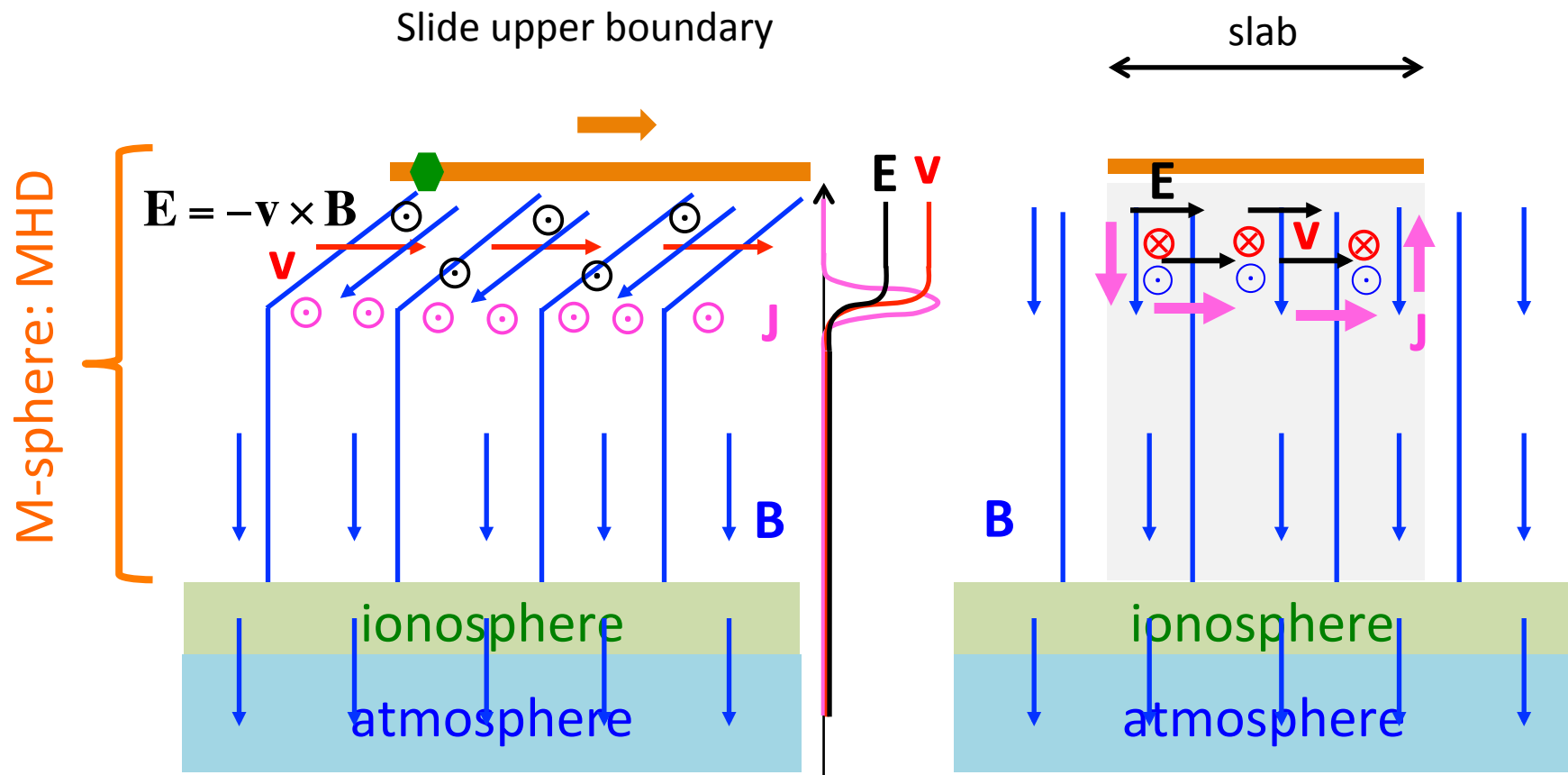

Example of how the motions meet

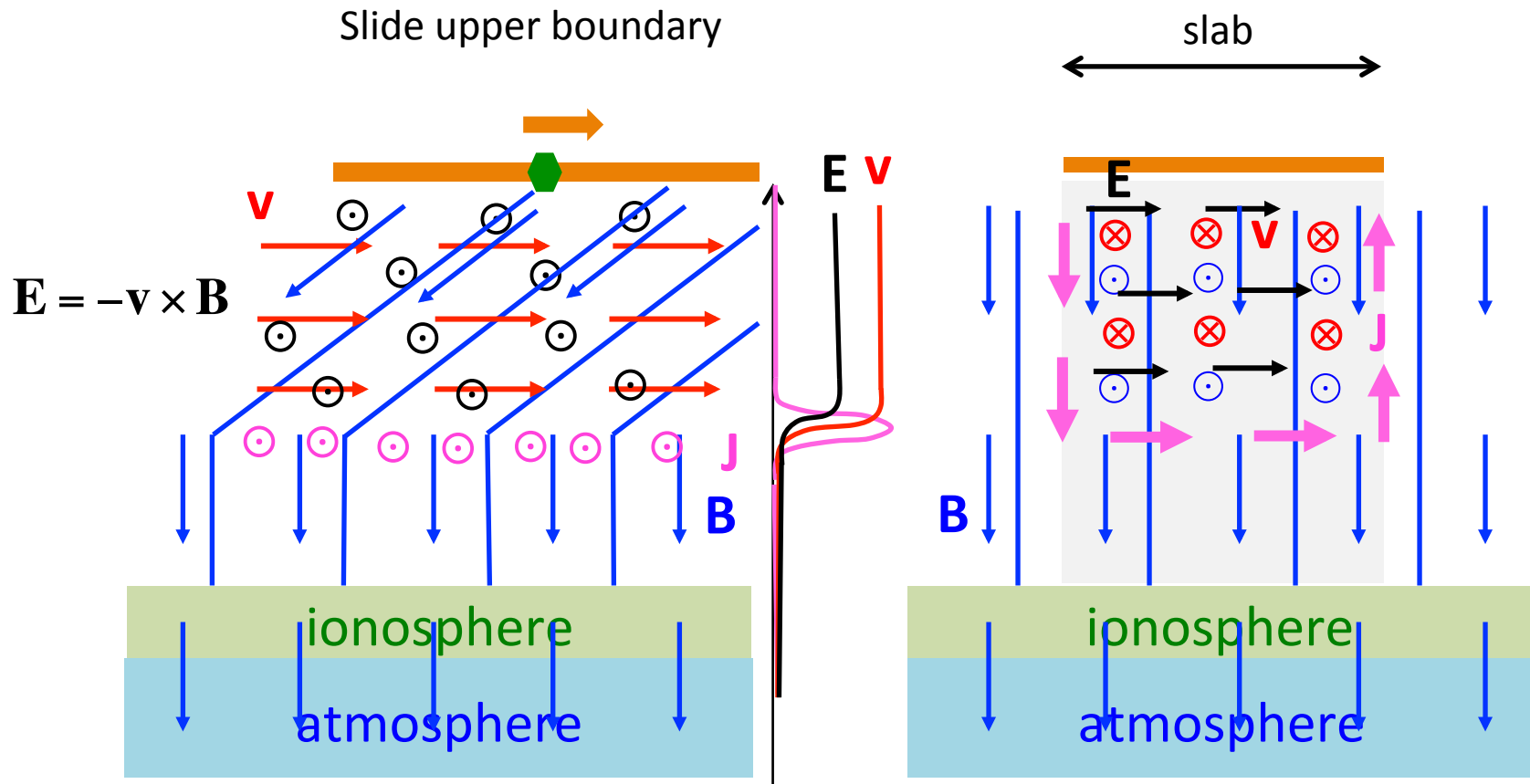

Example of how the motions meet

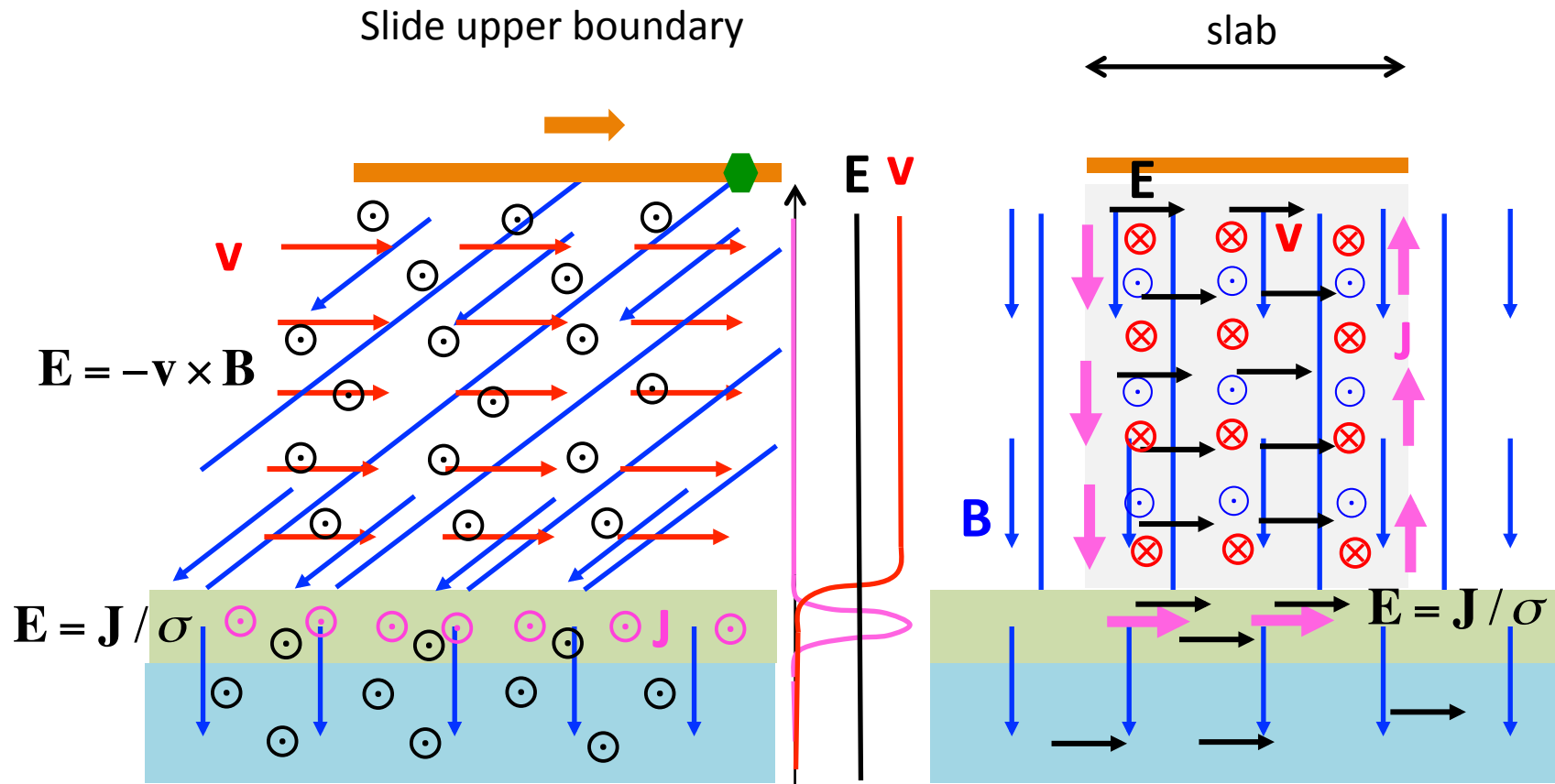

Example of how the motions meet

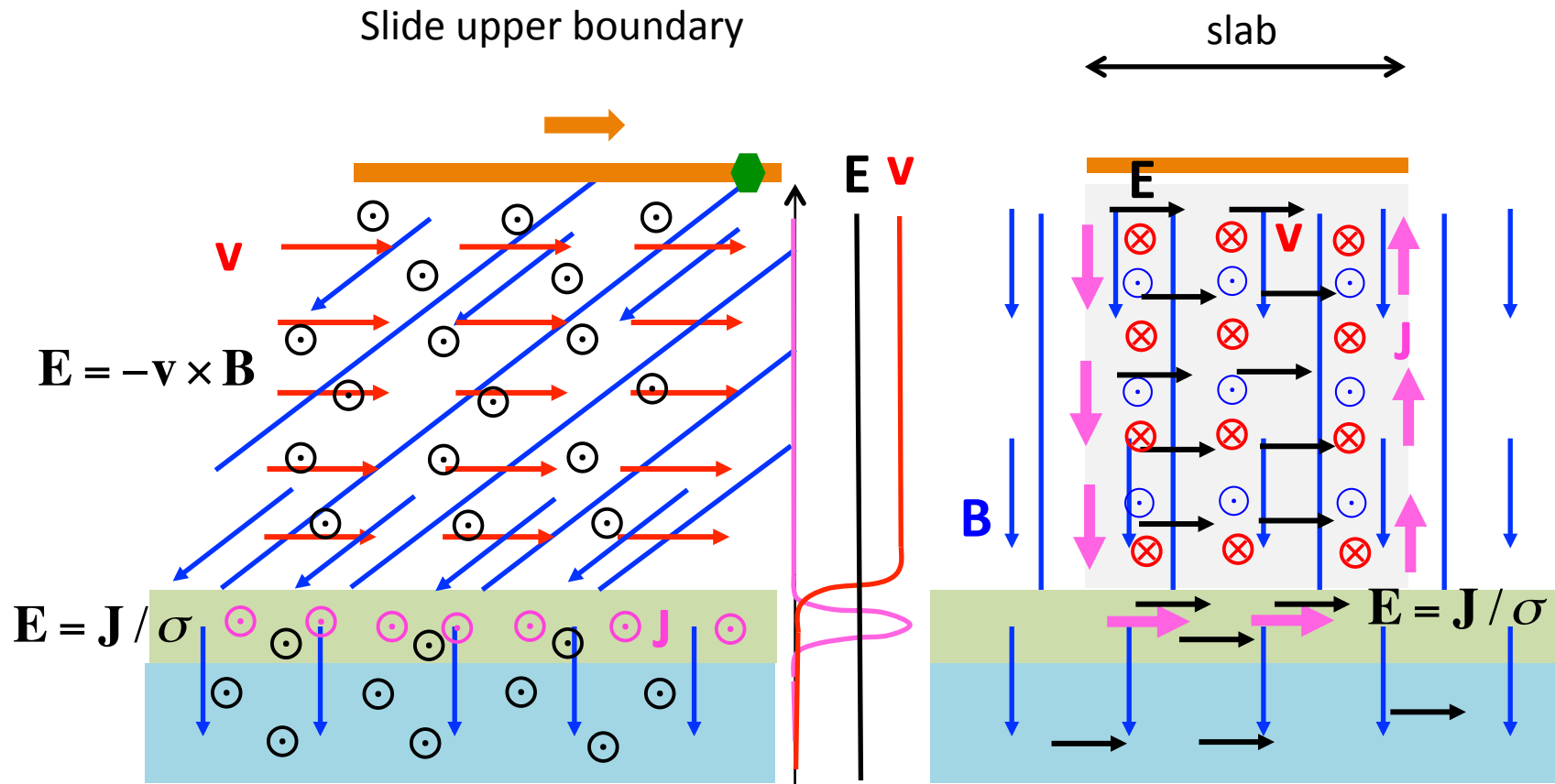

Example of how the motions meet

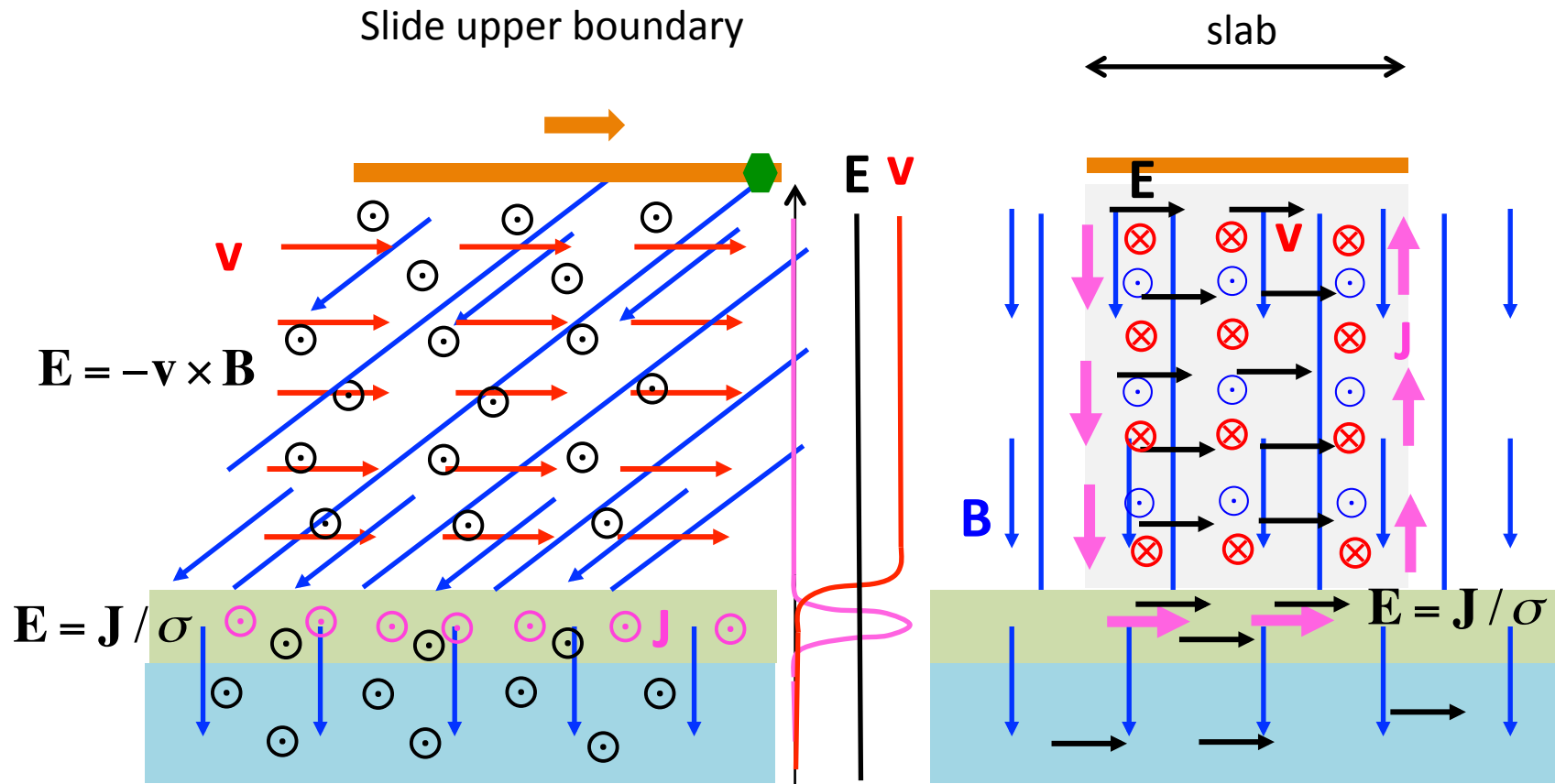

Example of how the motions meet

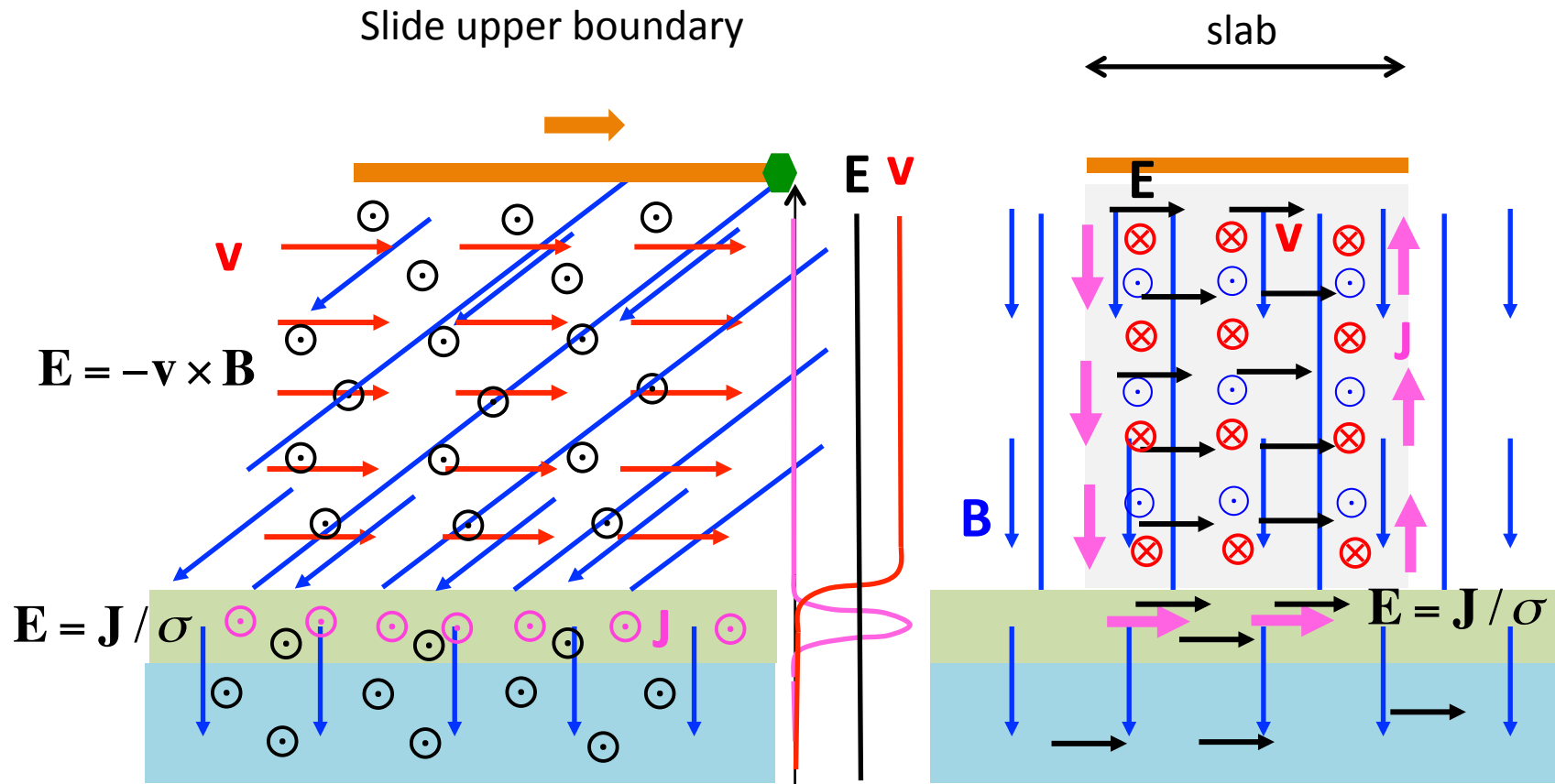

Example of how the motions meet

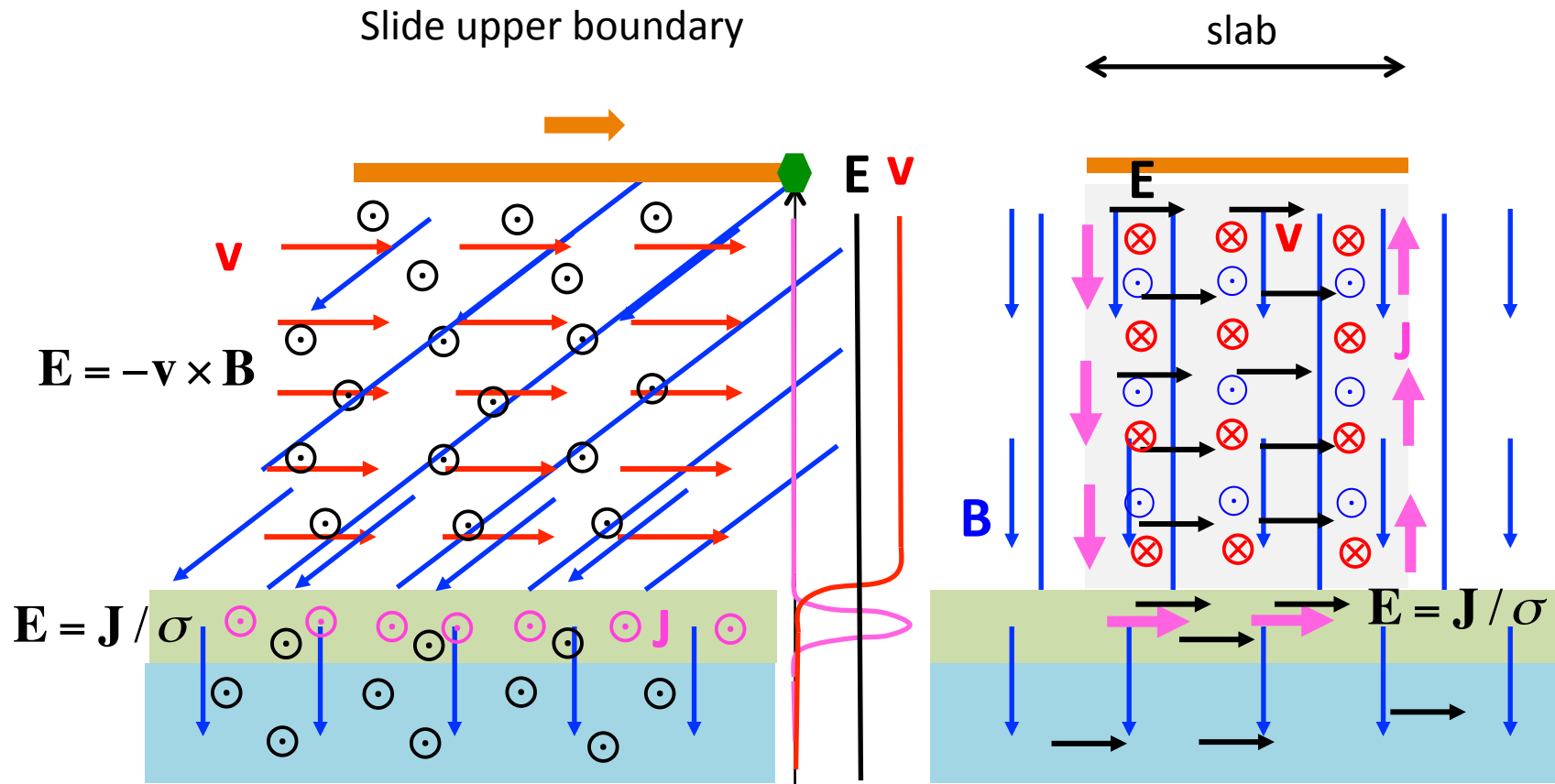

Example of how the motions meet

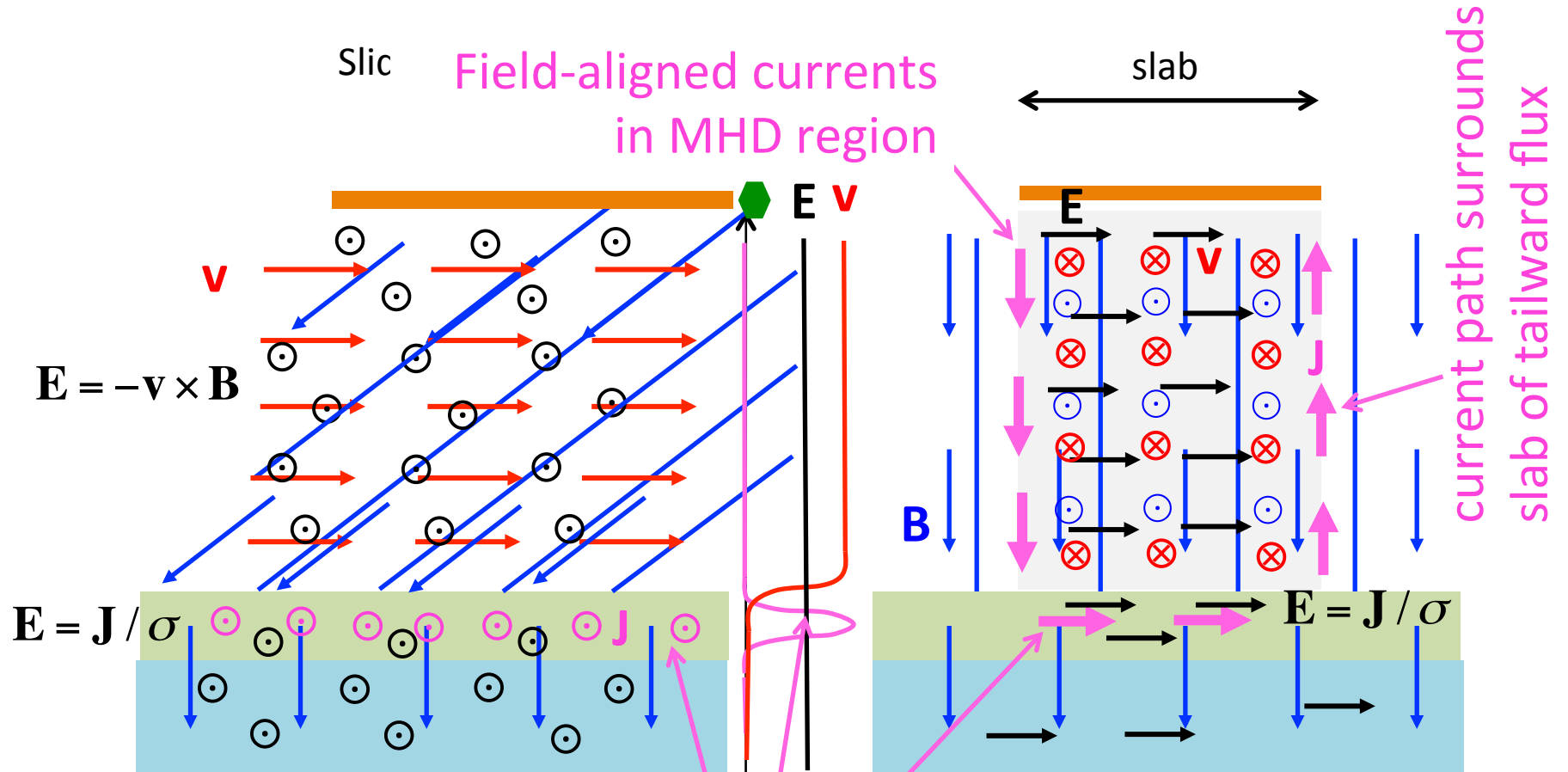

MHD Field line motion creates
 current in ionosphere – accompanied by \mathbf{E}

Convection: magnetosphere meets ionosphere

MHD motions drag footpoints across polar caps and back around to day side

Integrate* \mathbf{E} across polar cap:

$$\int_A^B \mathbf{E} \cdot d\mathbf{l} = \varphi_{pc} = \dot{\Phi}_{ds}$$

Really an EMF – but called “cross polar cap potential”

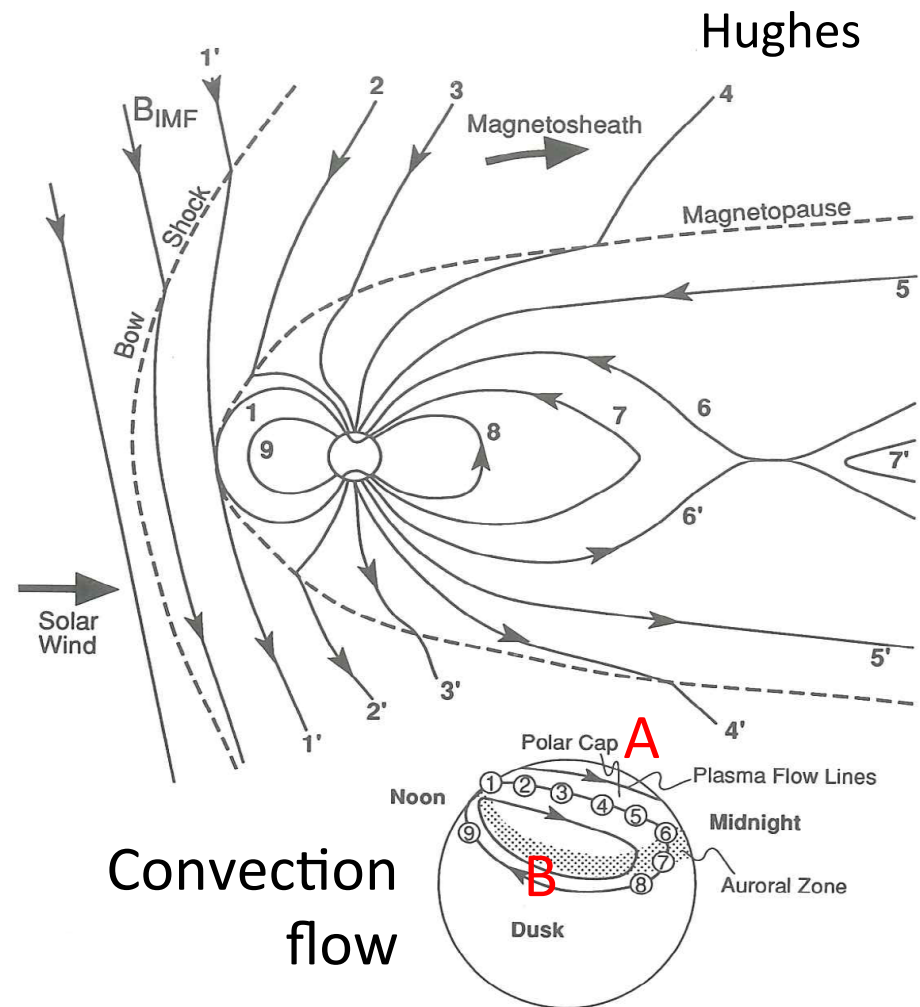

* use MKS here

$$\int_A^B \mathbf{E} \cdot d\mathbf{l} = \varphi_{pc} = \dot{\Phi}_{ds}$$

Field-aligned
currents in MHD
region

Convection
flow

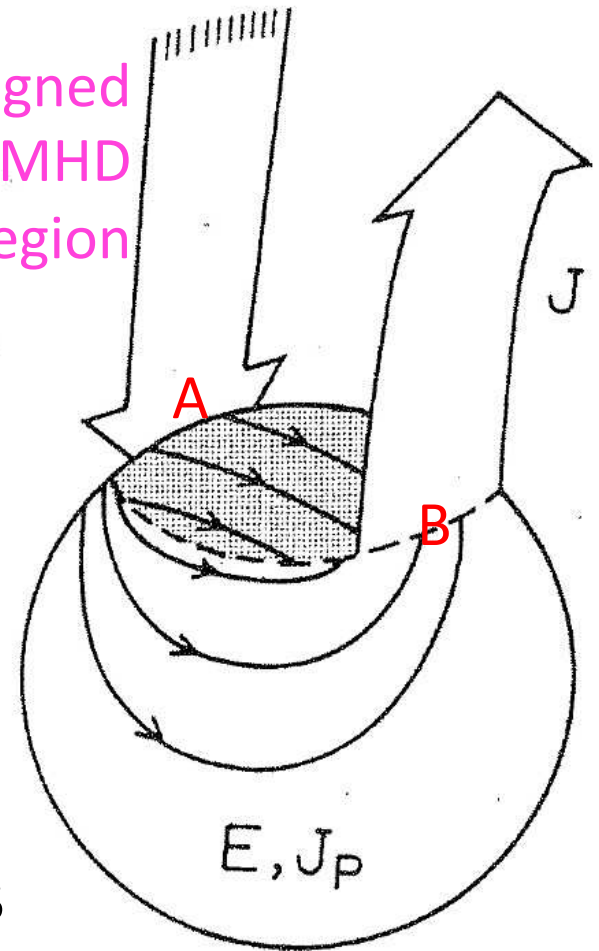
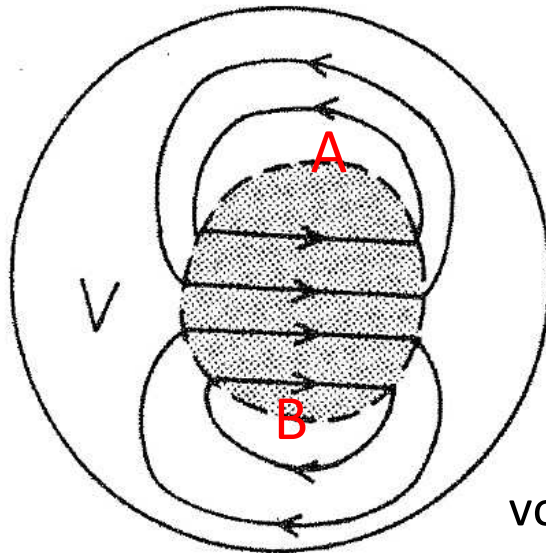

vol. I fig. 10.5

$$\begin{aligned} \phi_{pc} &= 50 \text{ kV} \\ &= 5 \times 10^{12} \text{ Mx/s} \end{aligned}$$

recycle in Φ_t in ~ 5 hours

Summary

- Ionospheres created by EUV & X-rays from Sun's TR and corona
- Diminish during night – lower during solar minimum
- SW deflected by ionospheres of unmagnetized planets (Venus & Mars)
- SW deflected by magnetospheres
- Magnetotail created by reconnection with solar wind magnetic field