

# Ionosphere-Thermosphere

Jan J Sojka

Center for Atmospheric and Space Sciences  
Utah State University, Logan, Utah 84322

- PART I: Local I/T processes (relevance for Homework Assignments)
- PART II: Terrestrial I/T system (relevance for Laboratory Tasks)

Heliophysics Summer School V: Boulder, Colorado 27 July to 3 August, 2011

Material adopted from the following authors.

- HSS lecture notes prepared by Professor Tim Fuller-Rowell (volume 1 HSS text book)
- Robert Schunk and Andrew Nagy: their text “Ionospheres”, a Cambridge press Atmospheric and Space Science Series book.

# Neutral Atmospheres

- All ionospheres exist in an atmosphere.
- The thermosphere-ionosphere forms the neutral to plasma interface between planets with atmospheres and space.
- The composition of the ionosphere is governed by the atmosphere and the ionizing radiation.
- The atmospheric dynamics influences the ionosphere.

# ATMOSPHERE

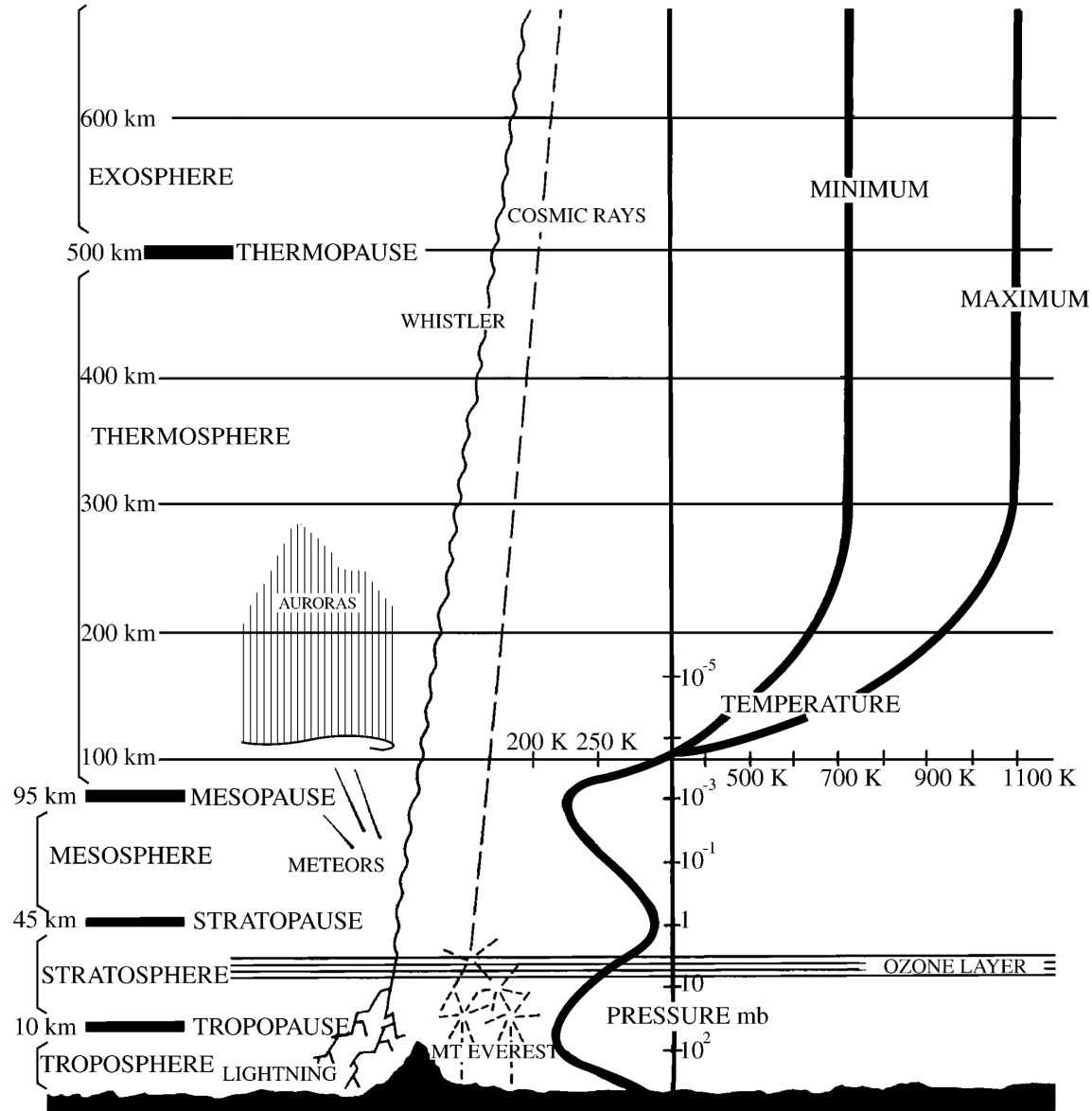

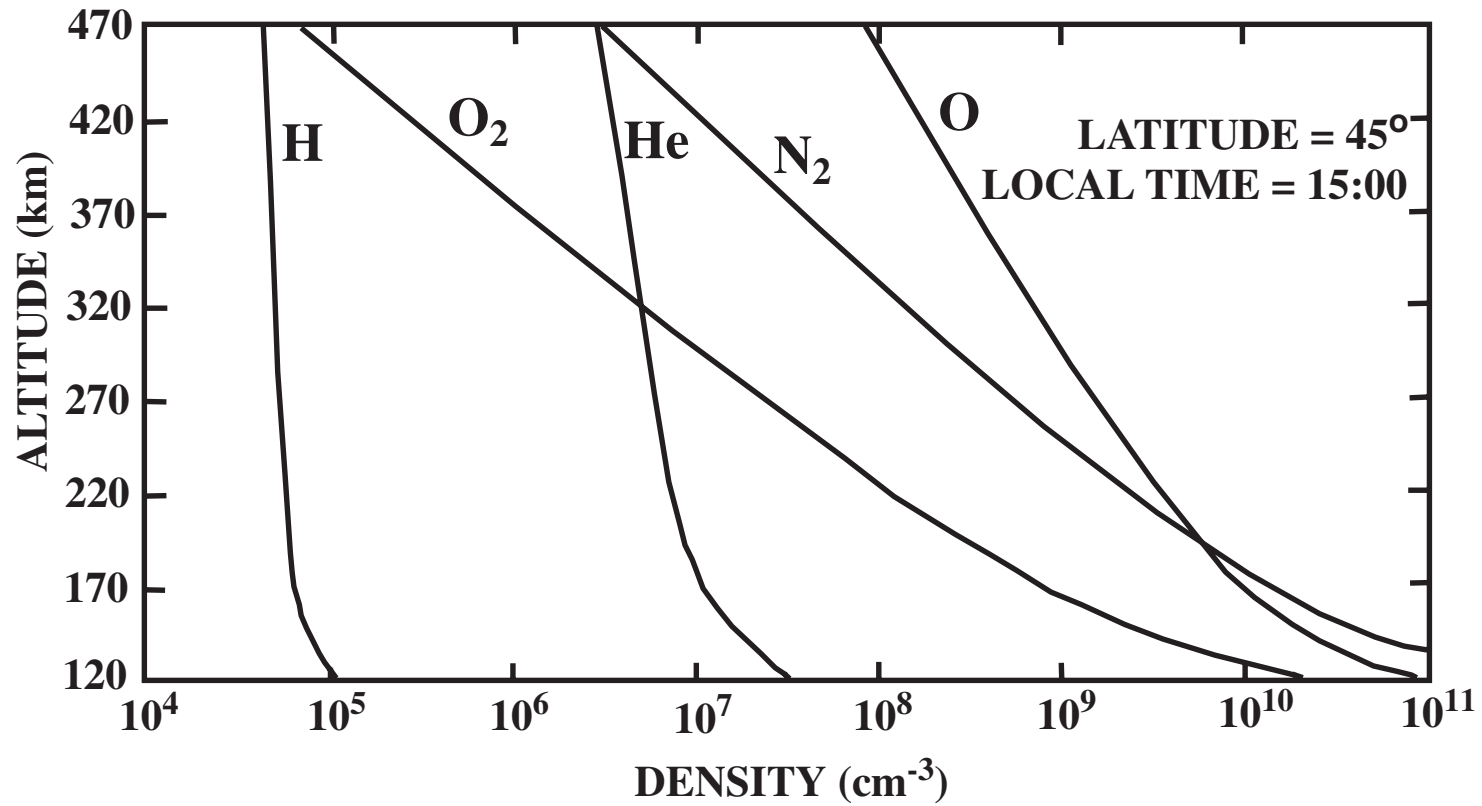

The Terrestrial Thermospheric composition: the basis for the ionosphere

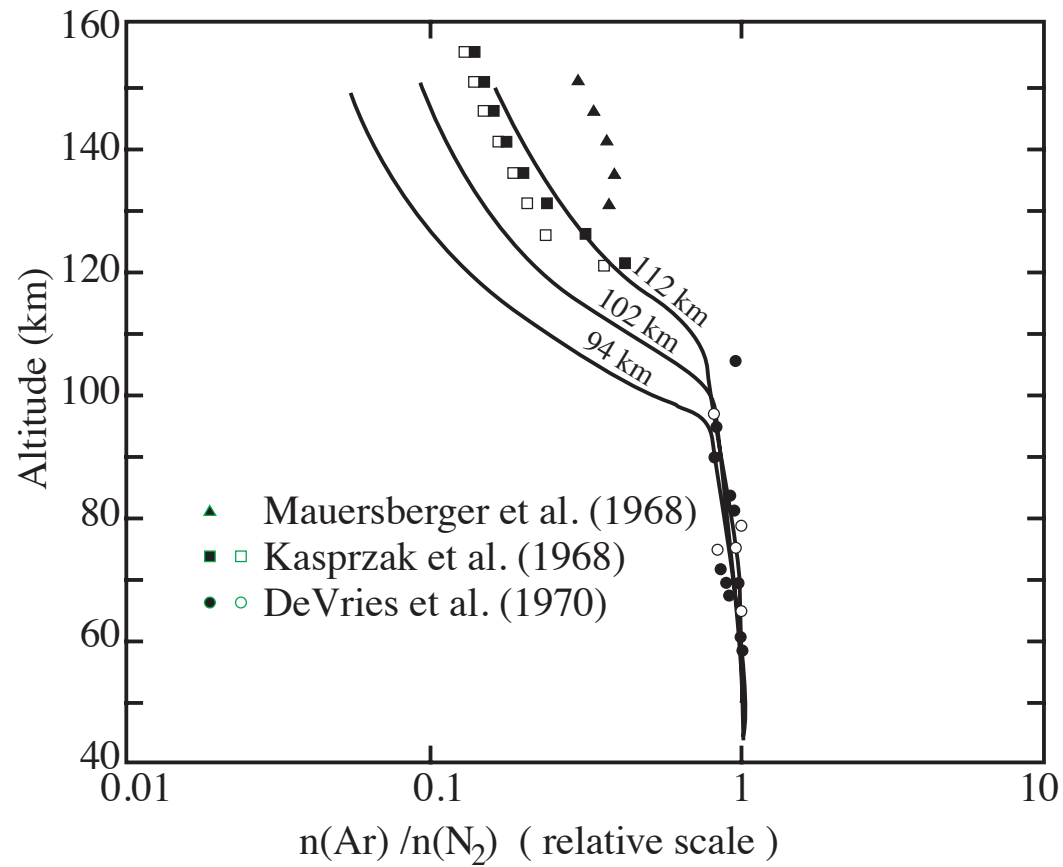

Lower atmosphere has turbulent mixing which leads to constant composition.

Above the turbopause the neutral species are in their own hydrostatic equilibrium.

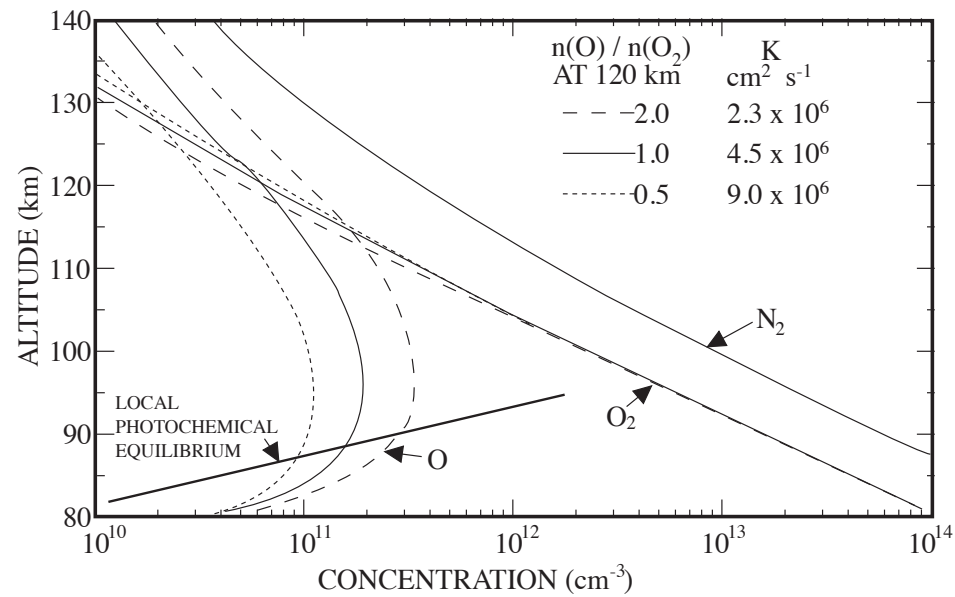

In the terrestrial upper atmosphere atomic oxygen is produced.

Atomic oxygen is associated with its own chemistry reactions.

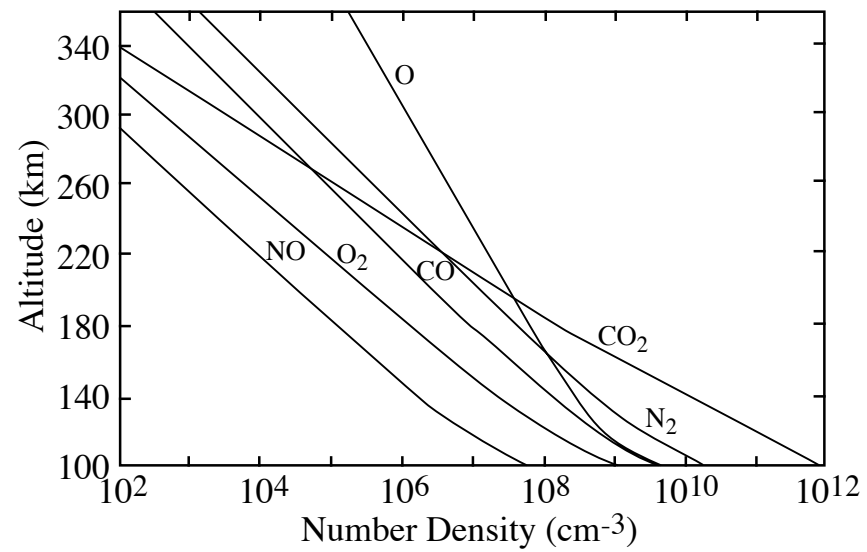

MARS, it also has an atmosphere!

Atomic oxygen is also present, as is a lot of carbon dioxide.



# Ionospheres

- Ionospheres exist in a neutral gas.
- The relative plasma to neutral density is variable.
- The daytime plasma is produced by solar EUV soft X-ray ionization.
- The ionosphere is electrically coupled to the magnetosphere.
- The terrestrial ionospheres natural coordinate system is the Earth's magnetic field.

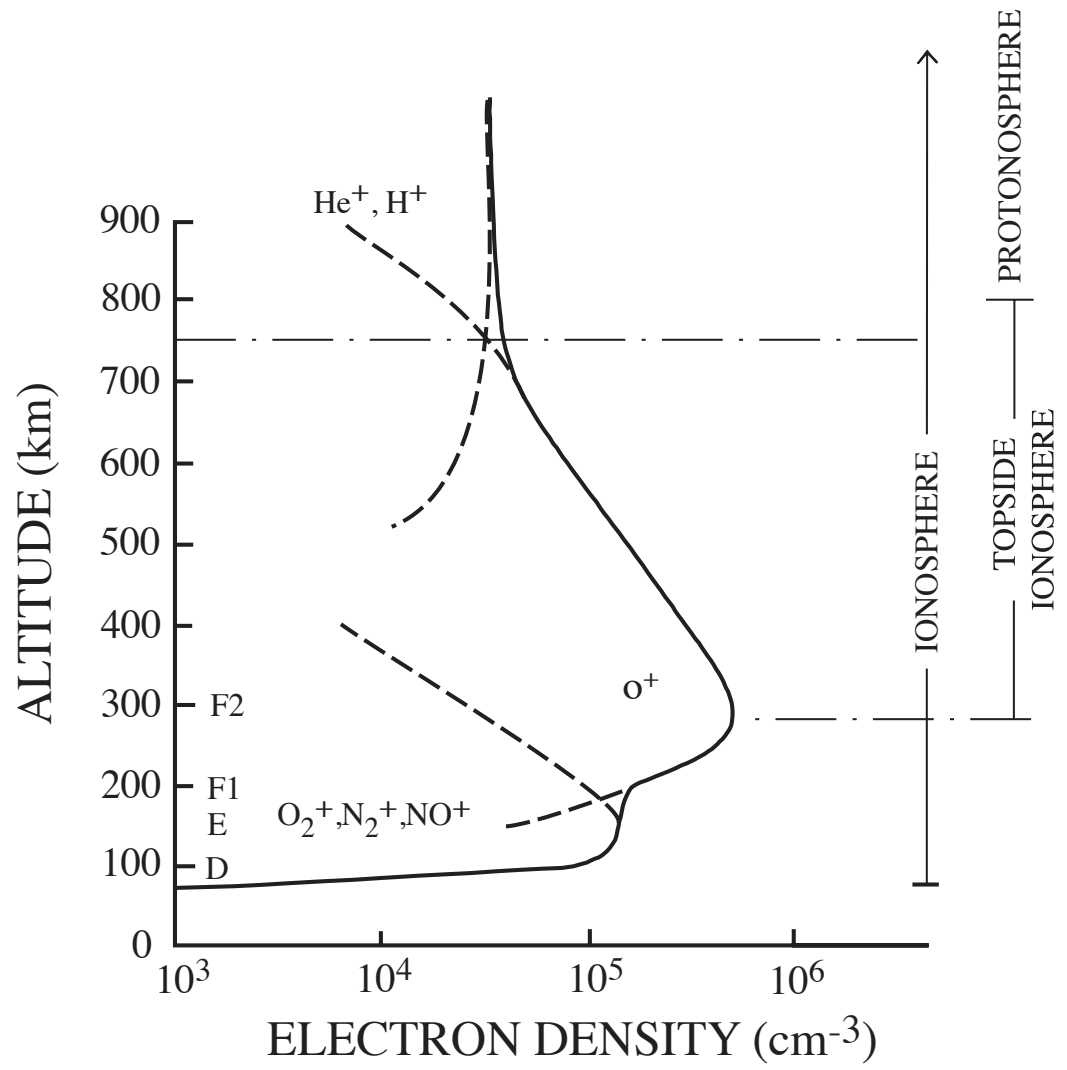

## O+ F2 Layer

Above the peak it is in diffusive equilibrium with its plasma scale height.

Below the peak chemistry dominates, but molecular composition creates a large range of chemical reactions and temperature dependencies.

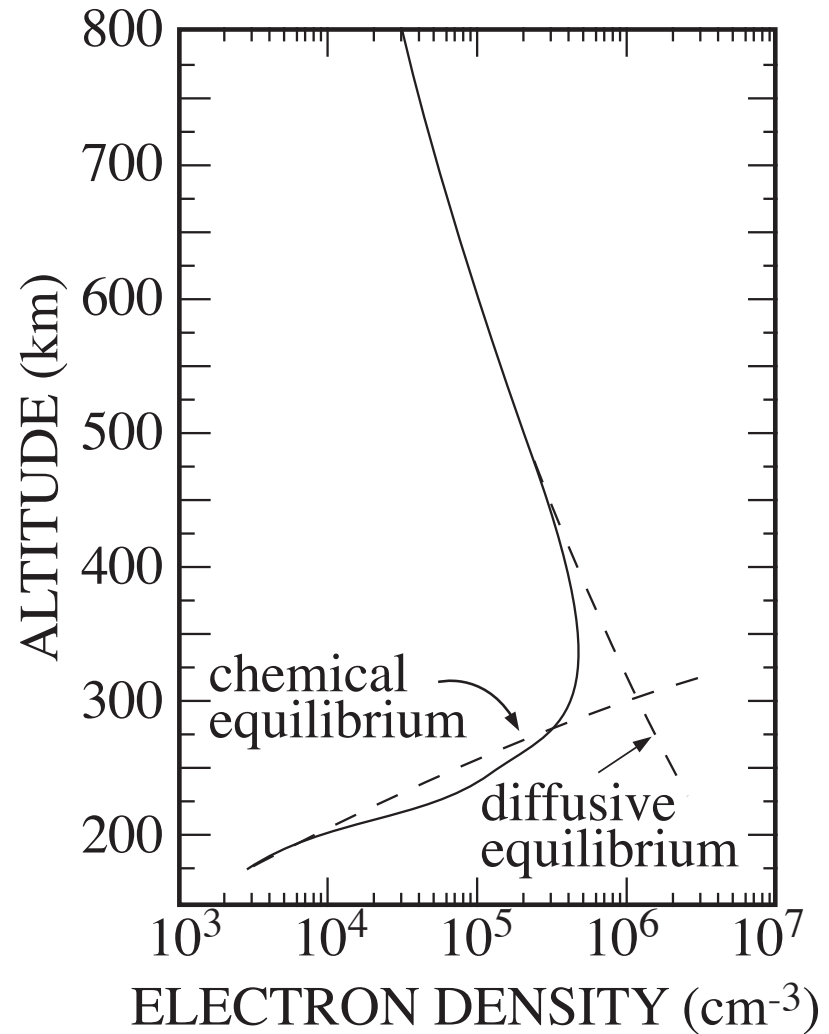

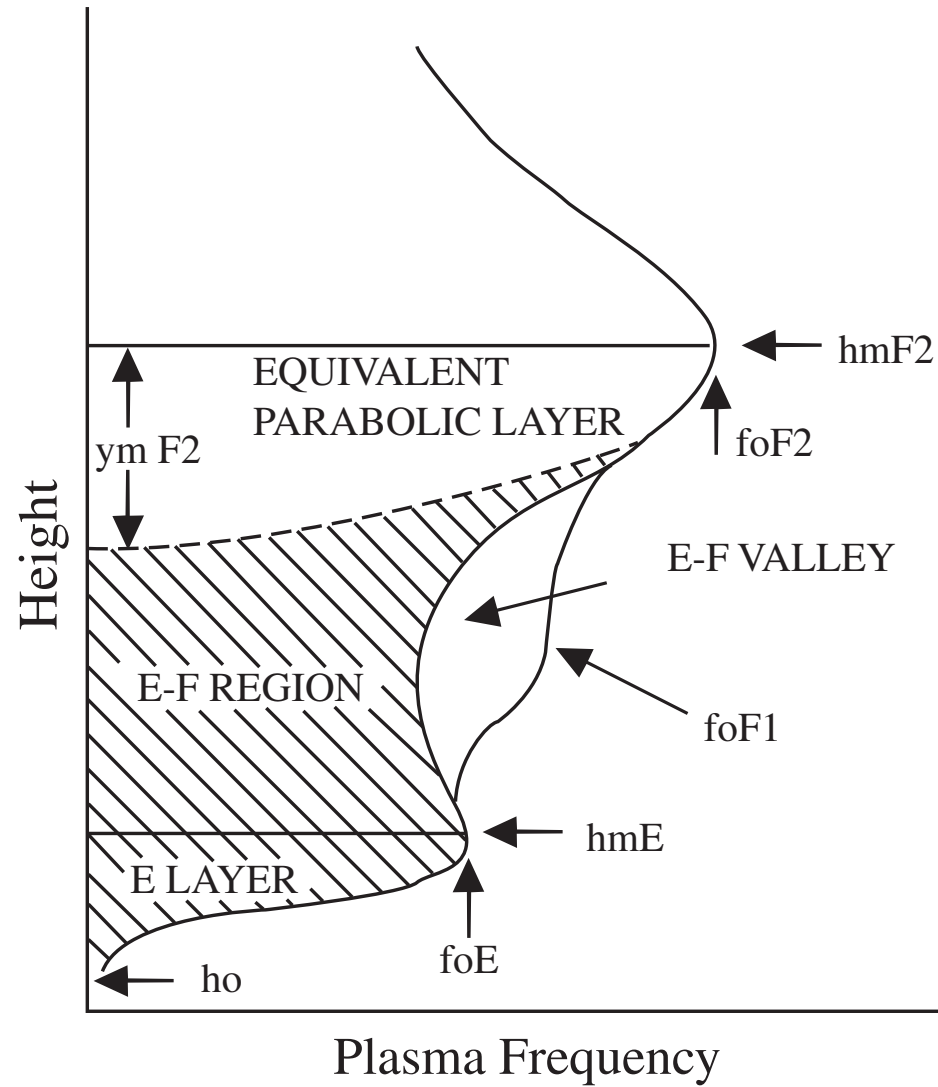

Nomenclature and simple mathematical functions for the ionosphere.

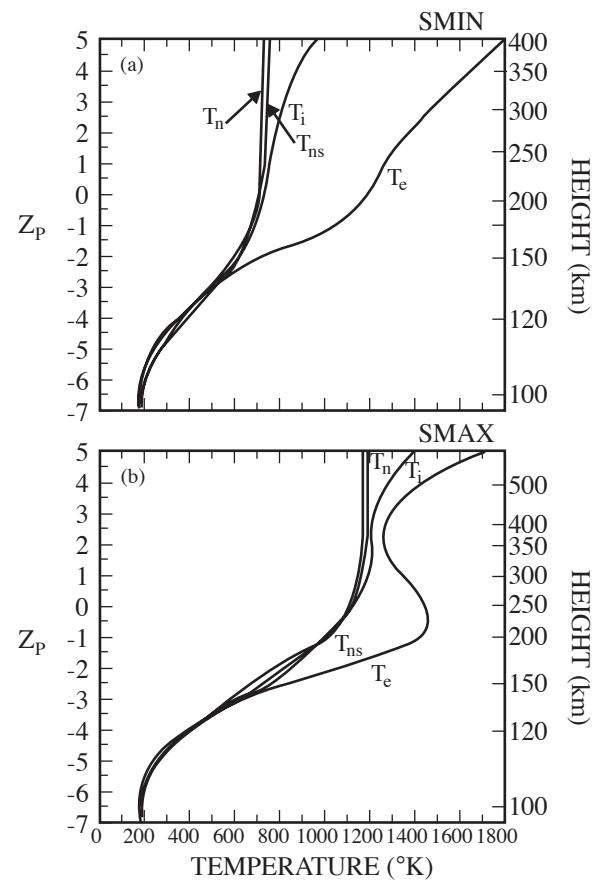

A natural coordinate for the atmosphere is the pressure level!

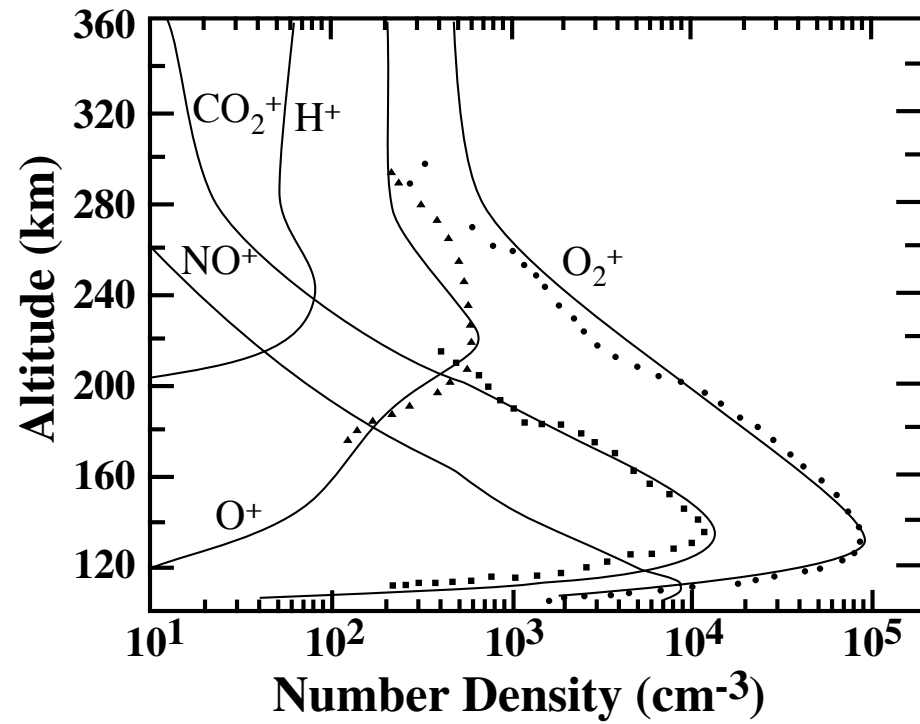

MARS has an ionosphere!

The ionosphere is dominated by the molecular ion O<sub>2</sub><sup>+</sup>, that on the Earth would be called the E-region.

# Photoionization

- The Solar EUV irradiance is key.
- Only recently has the short wavelength component become routinely observable.
- Proxy indices are less than satisfactory!
- NASA: satellites TIMED(SEE) and SDO(EVE) have provided high resolution spectral and now temporal information about EUV irradiance variability.

(a)

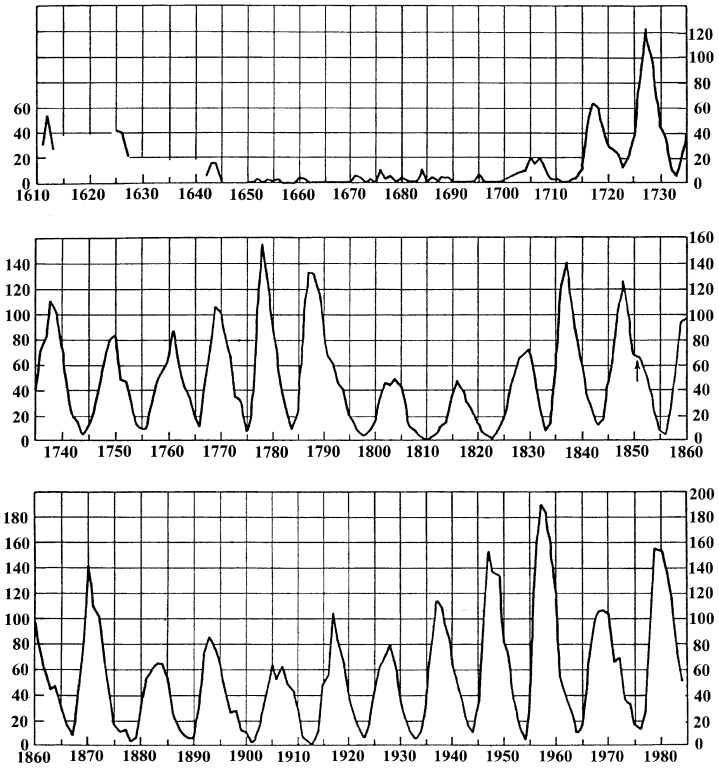

(b)

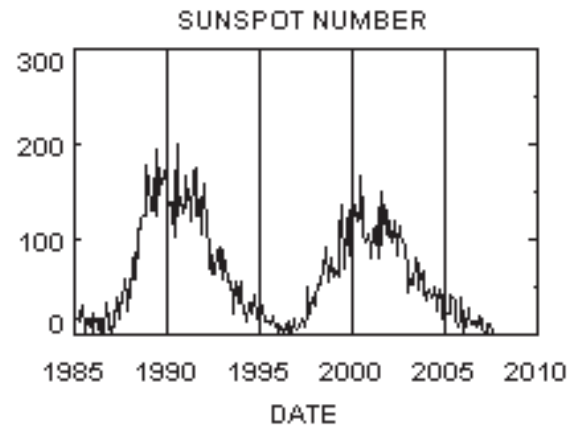



# Solar EUV and Soft X-Ray Flux

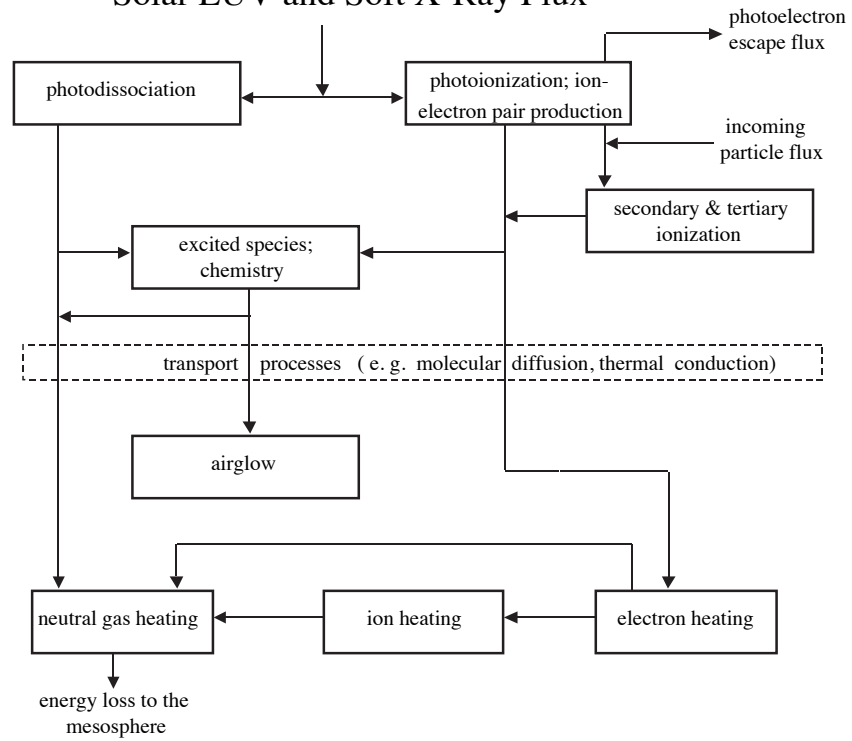

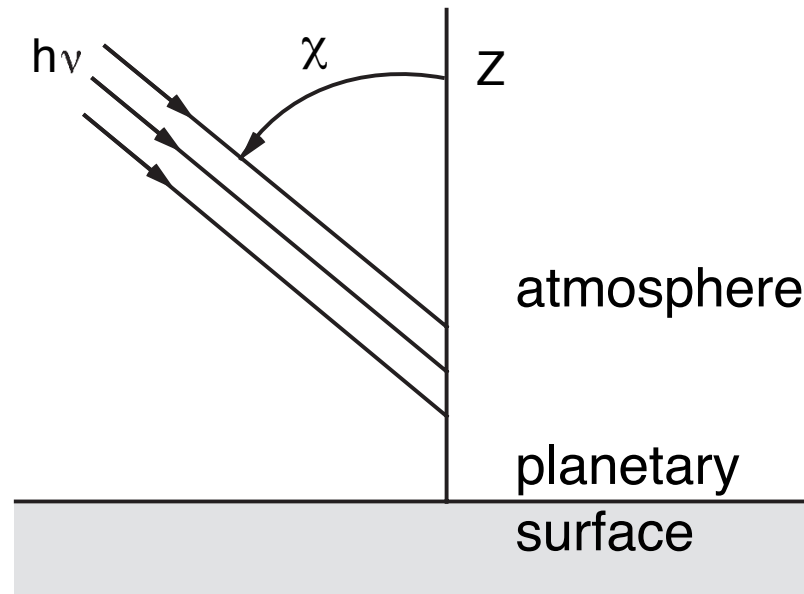

Solar Zenith angle geometry

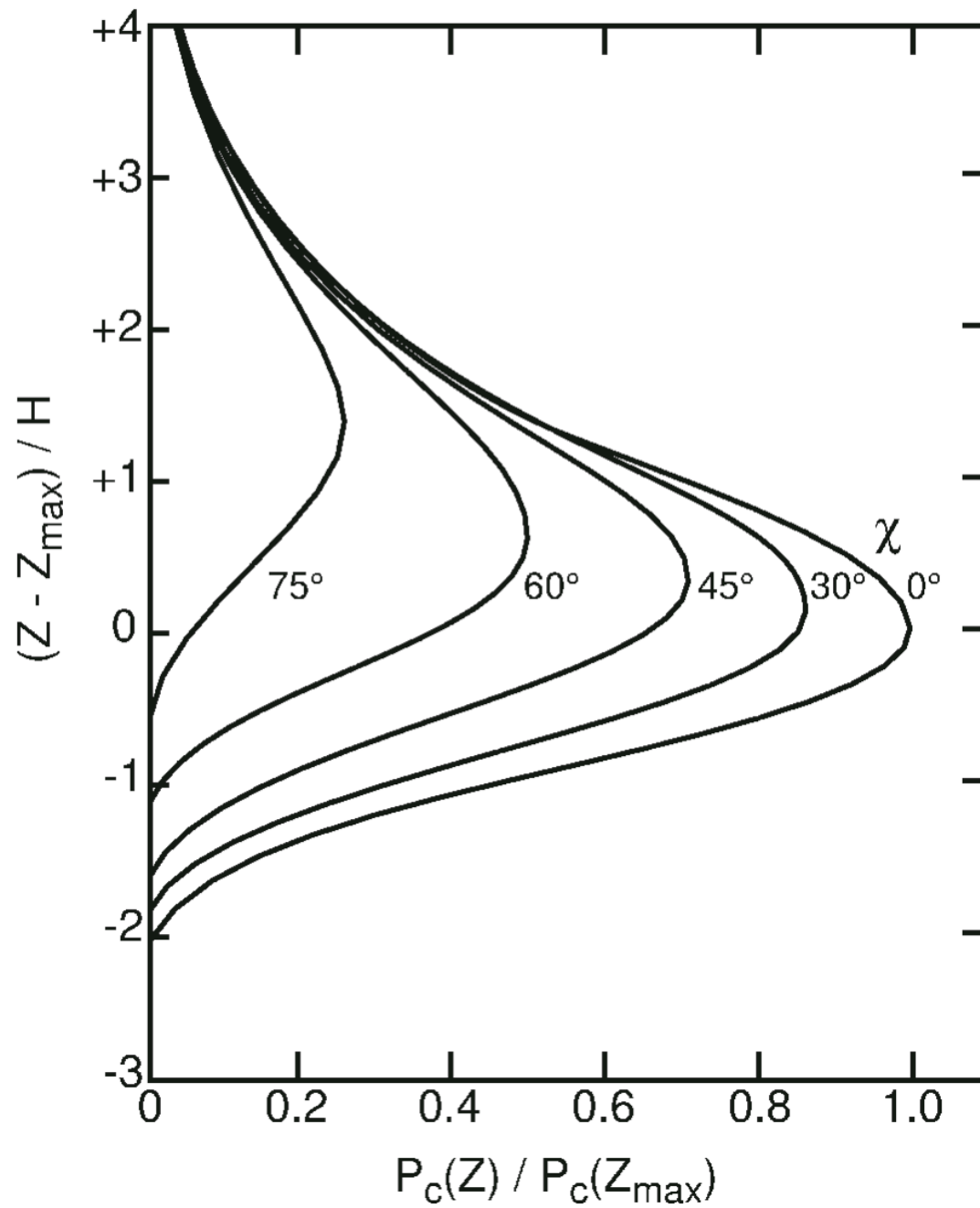

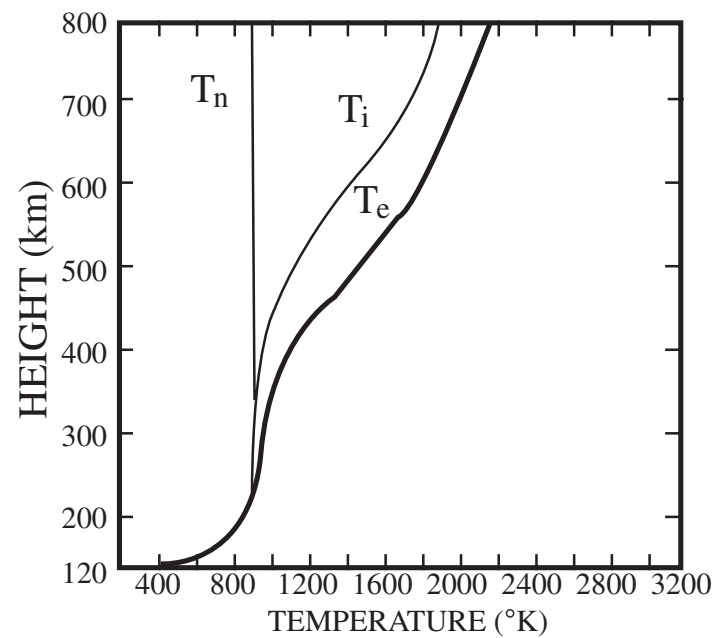
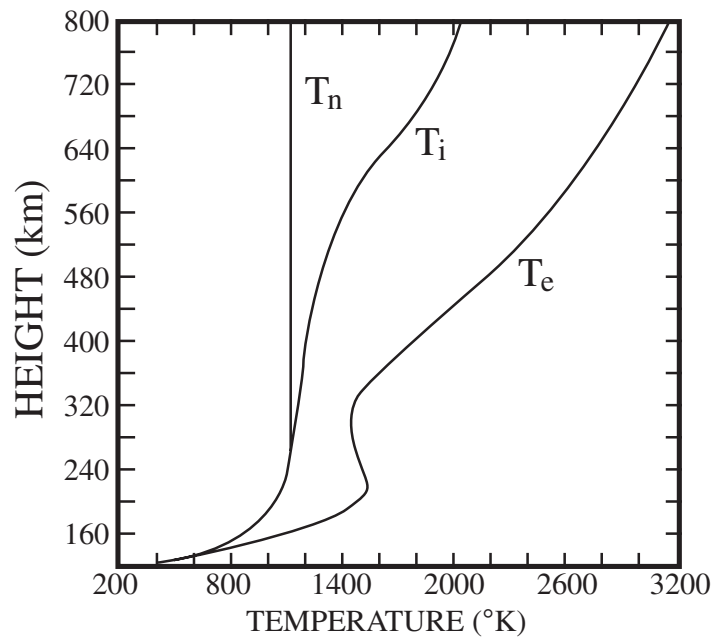

Daytime thermal profiles for the thermosphere and ionosphere at Millstone Hill, MA.

A midlatitude location: left panel 14:22 LT, right panel 02:22 LT at equinox in 1970.

# Auroral Ionization

- The magnetosphere generates ionization via energetic particles, usually electrons.
- These particles are energized in the magnetosphere and create ionization and heating in the thermosphere-ionosphere.
- Auroral displays are the manifestation of this process.
- Ionospheric conductivity is a dynamic “resistor” in the M-I electro-dynamics (MHD).

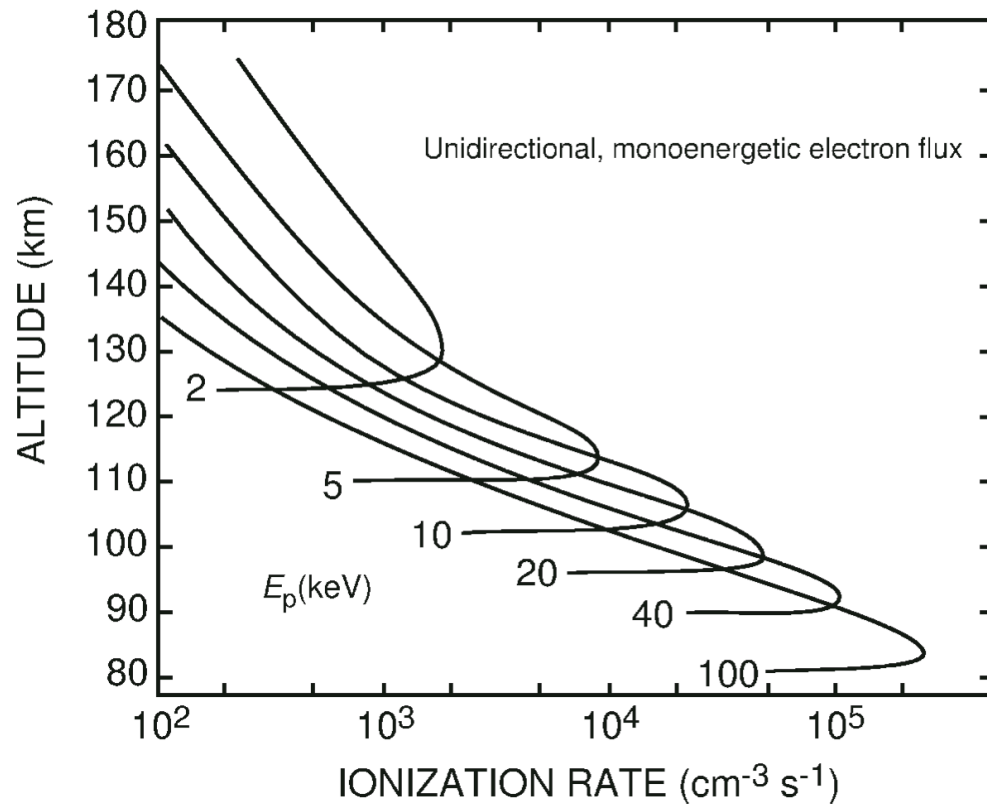

The altitude of ionization depends upon the energy of the auroral particles

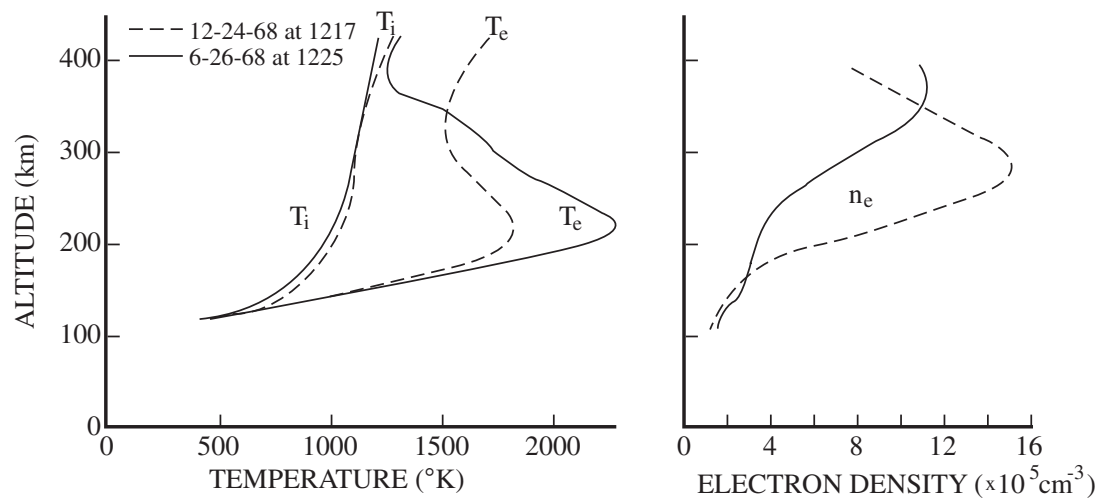

The auroral electrons precipitation leads to heating and density increases in the ionosphere

# Electric Fields and Winds

- In the F-region the electric field and neutral winds can induce plasma drifts to raise and lower the F-Layer.
- This modifies the plasma diffusion balance and hence density and profile shape.
- The ionosphere also corotates.
- At all latitude  $E \times B$  can transport plasma perpendicular to the magnetic field line.



The Earth's magnetic field is a poor dipole!

But many models still use a dipole representation!

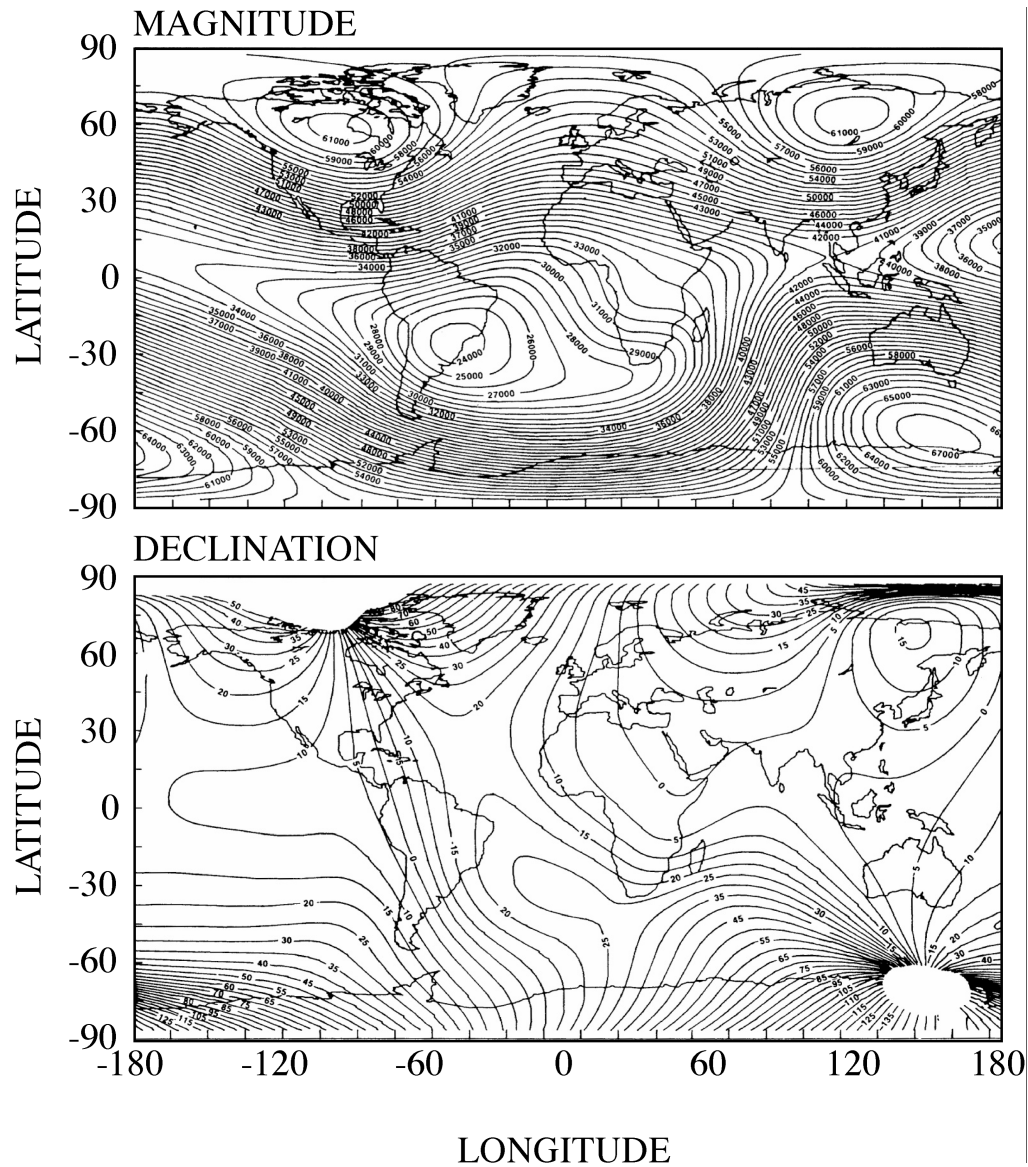

Equatorward wind at mid latitudes with inclined magnetic field pushes plasma upward along the magnetic field direction to regions of different neutral composition

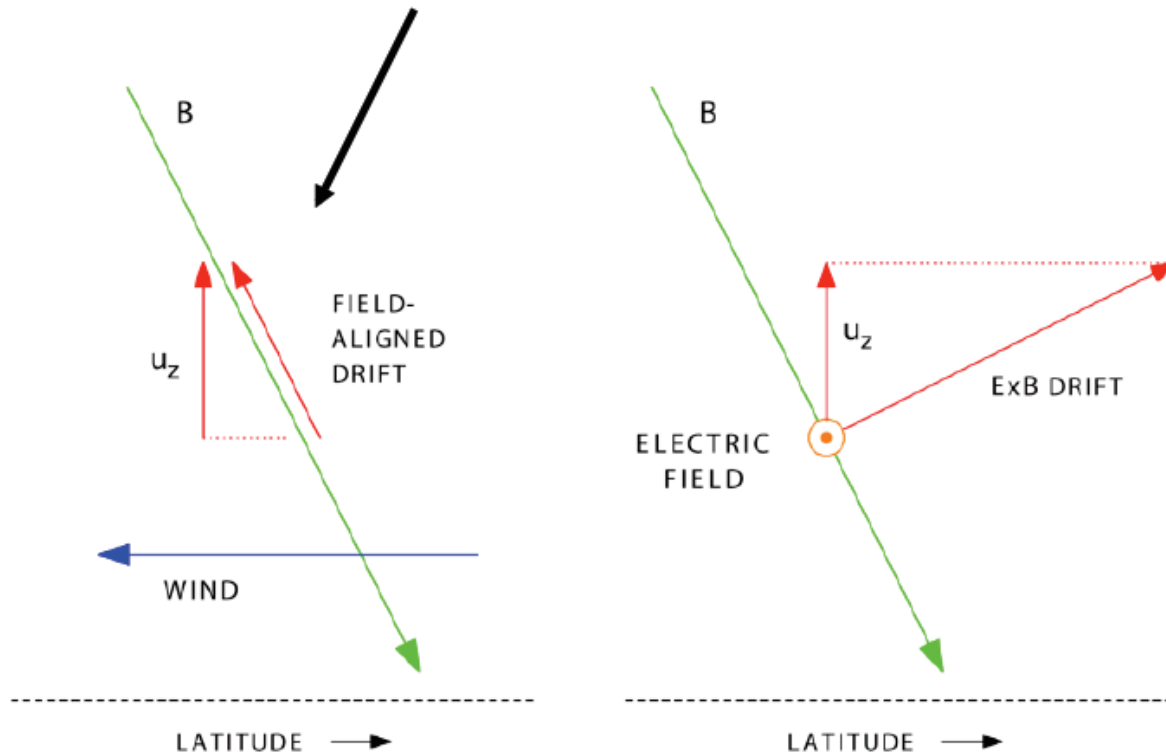

**An Eastward Electric field together with the magnetic field creates an upward plasma drift.**

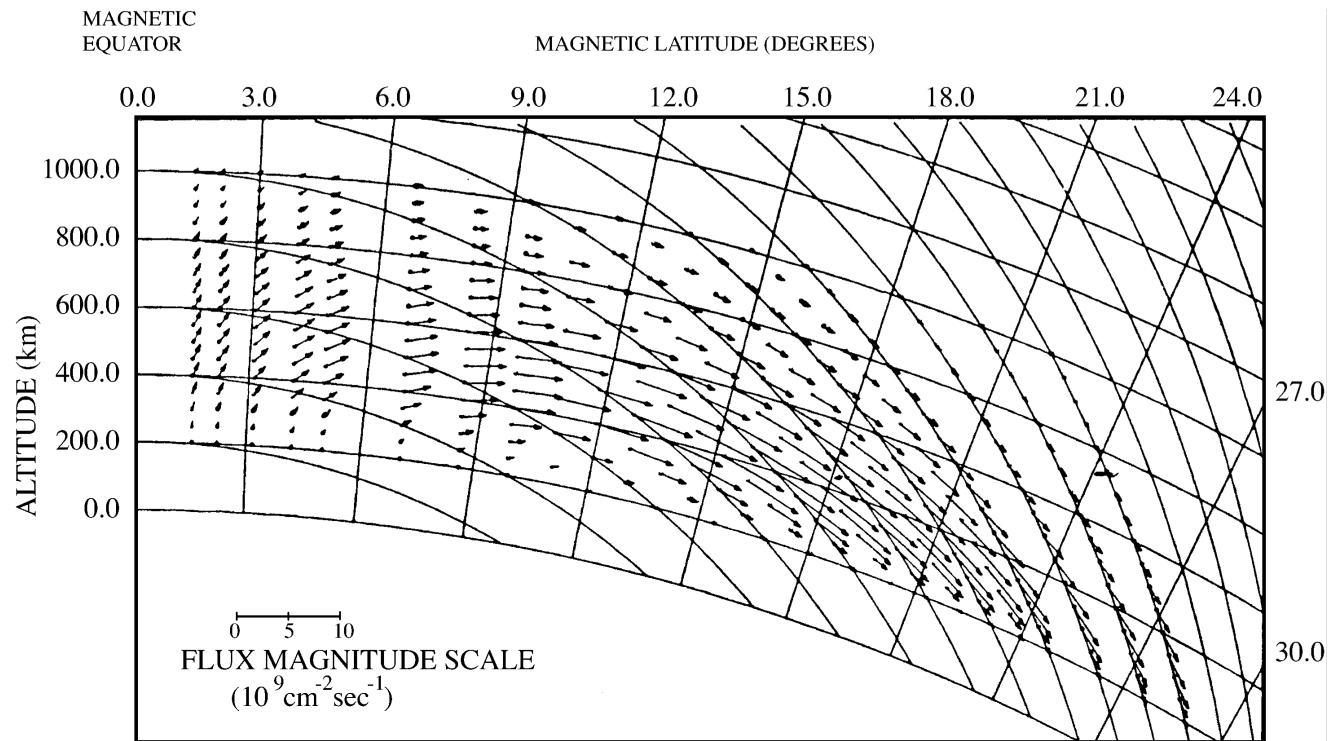

The low latitude day time ionosphere is dominated by transport caused by the Eastward electric field. This results in plasma redistribution and the formation of the Appleton Anomaly (equatorial anomaly).

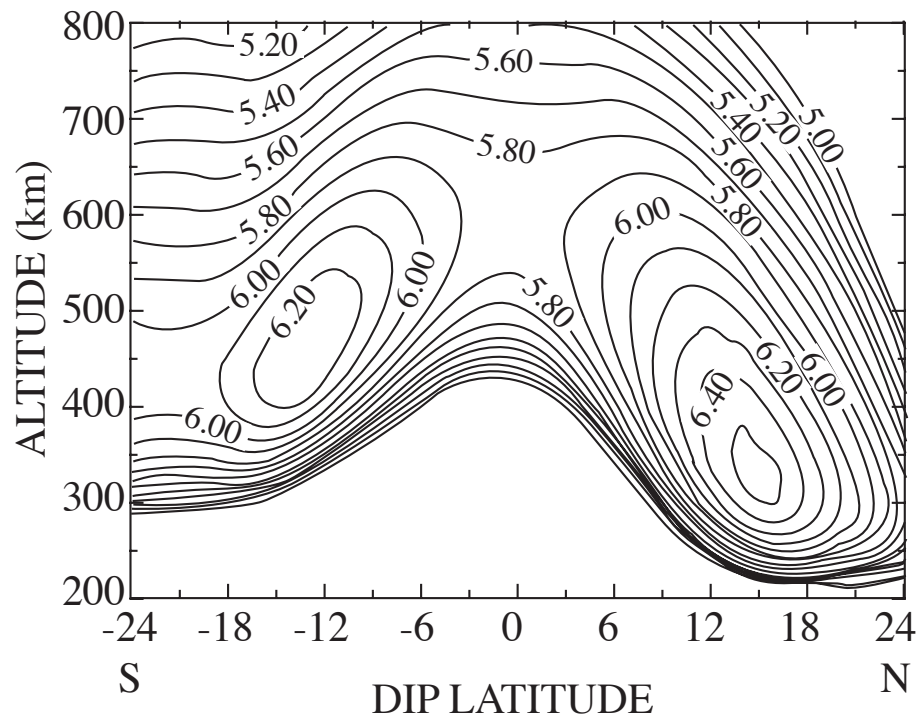

The Appleton anomalies also known as the Equatorial anomalies.

The F-region densities are shown as Log<sub>10</sub> Ne (cm<sup>-3</sup>)

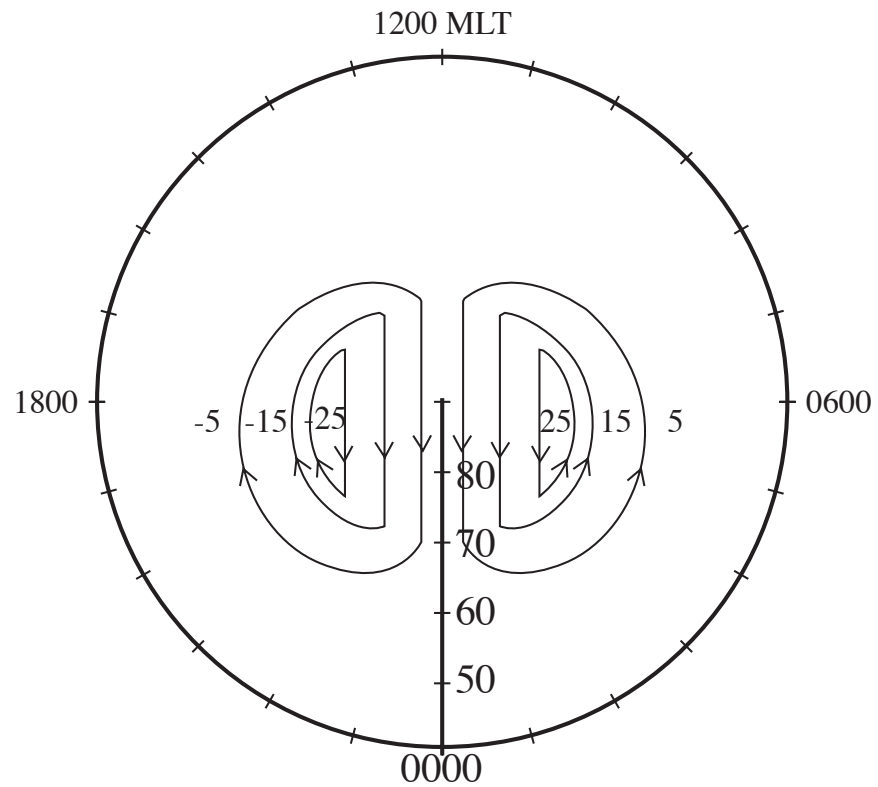

Schematic polar plot of the electric field called a 2-cell pattern.

The F-region plasma  $E \times B$  drift trajectory directions are shown by the arrows.

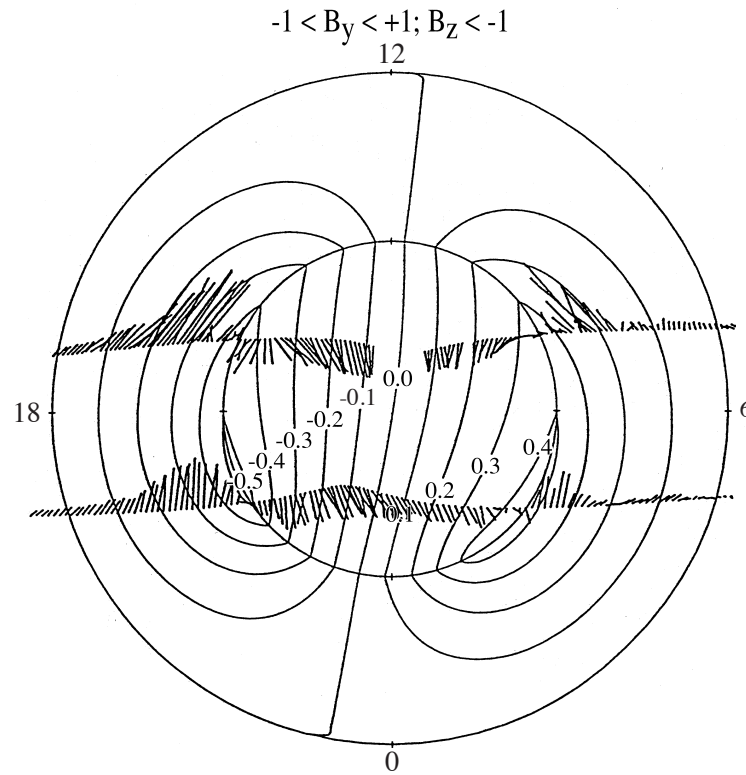

Observed ionospheric plasma drift velocities,  
over-layed with a corresponding 2-cell electric field pattern

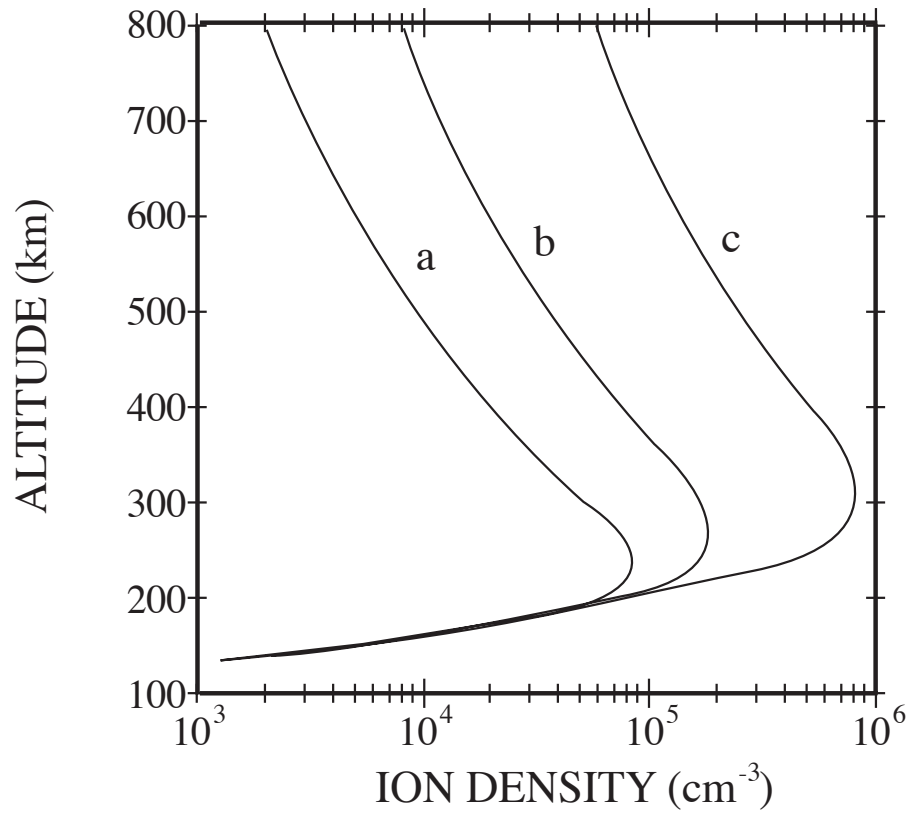

The effect of the E X B induced electric field (or wind) on the ionospheric density and profile.

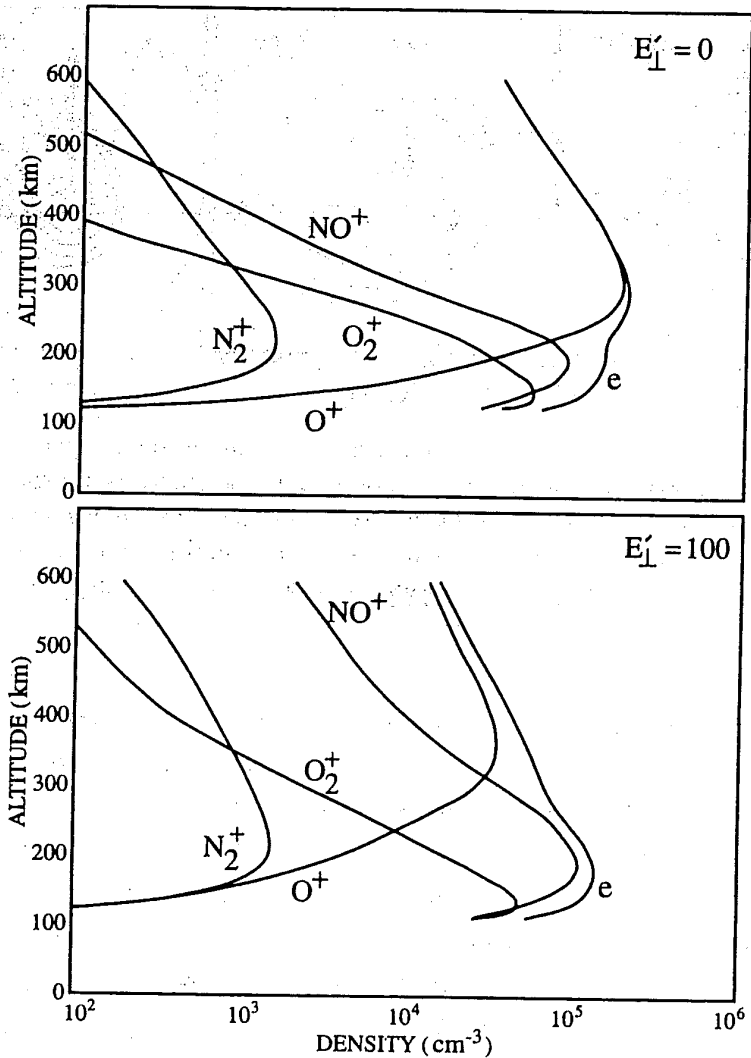

$O^+$  F2-layer is the dominant ionospheric layer under quiet geomagnetic conditions.

However, during very disturbed geomagnetic conditions the rapid conversion of  $O^+$  into  $NO^+$  leads to a E/F1 layer becoming dominant.



# PART-II

- Morphology of the ionosphere is a systems level problem.
- Many physics processes operate together as a system.
- Historically studies attempted to understand these processes individually and then “assimilate” their net effects..... NOT A GOOD APPROACH!

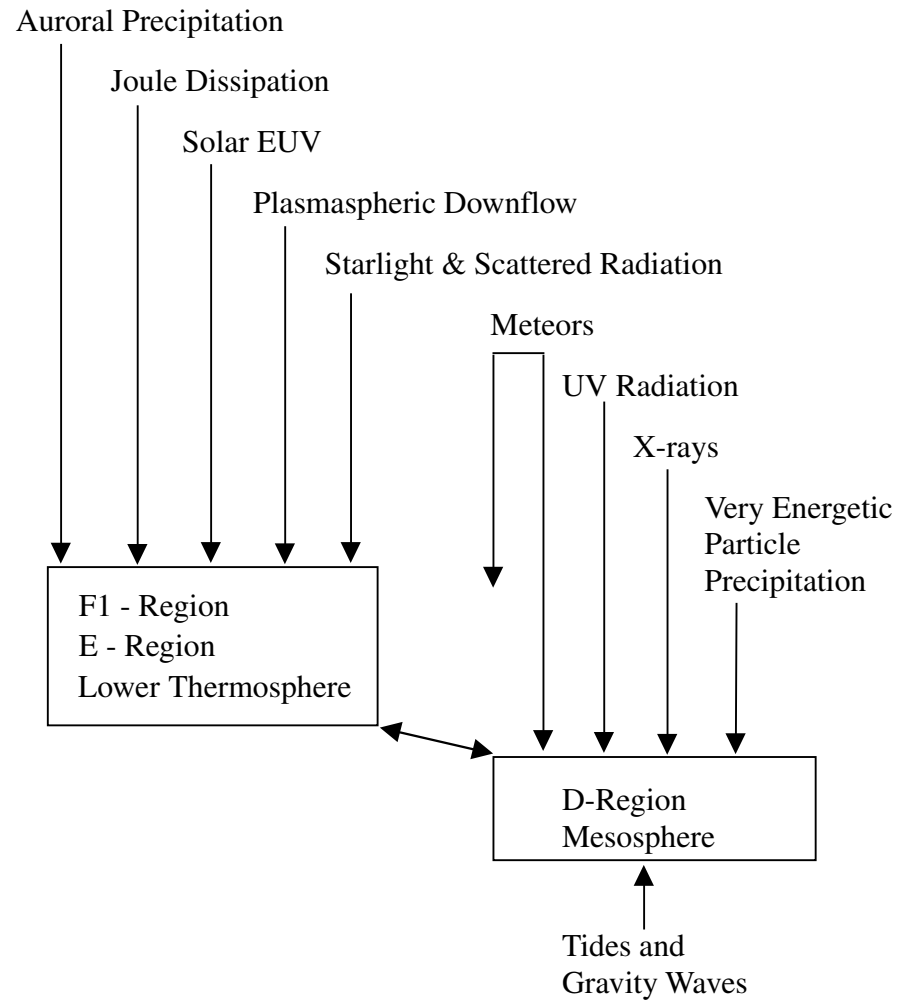

# Terrestrial Atmosphere ITM Processes

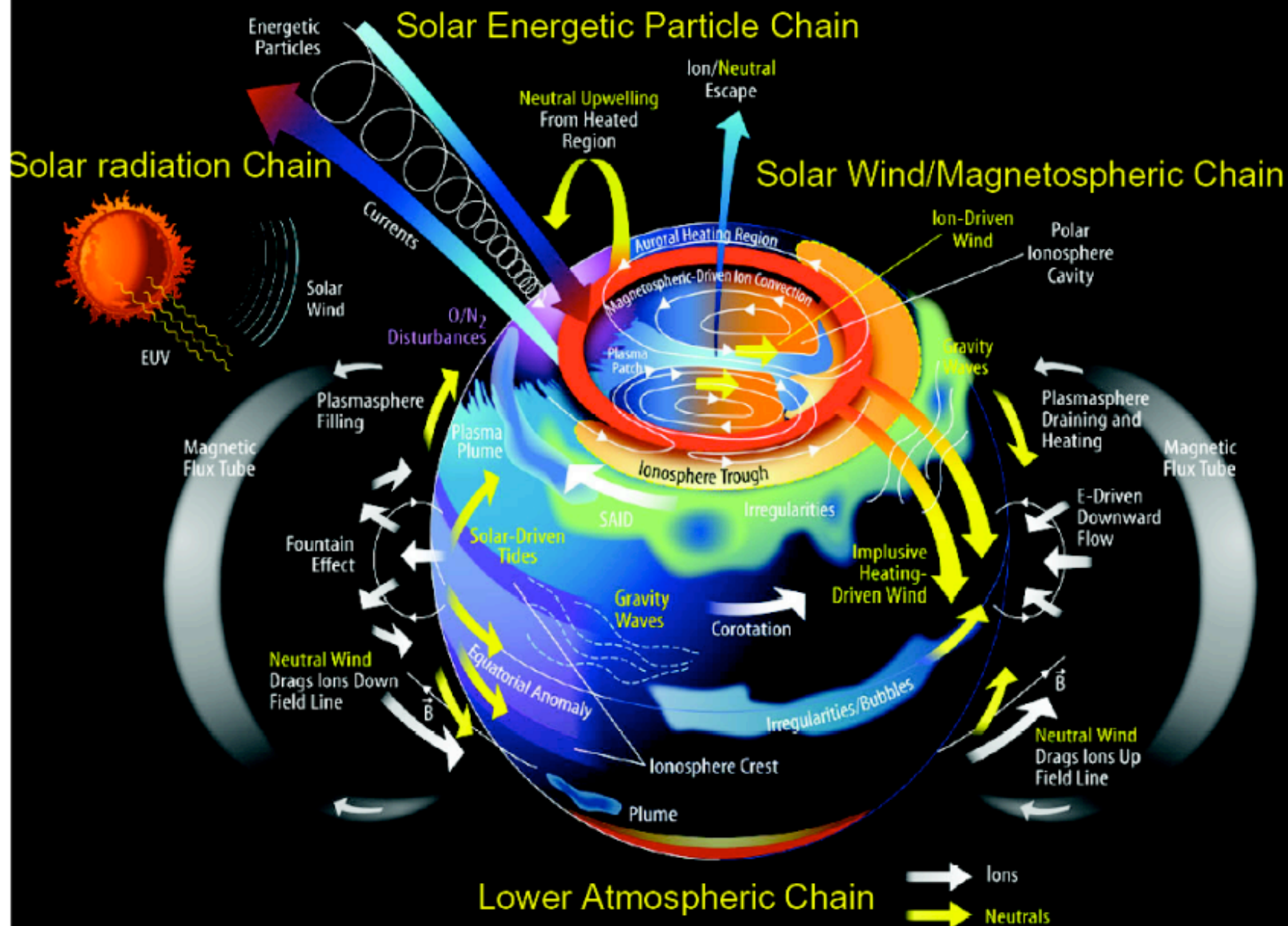

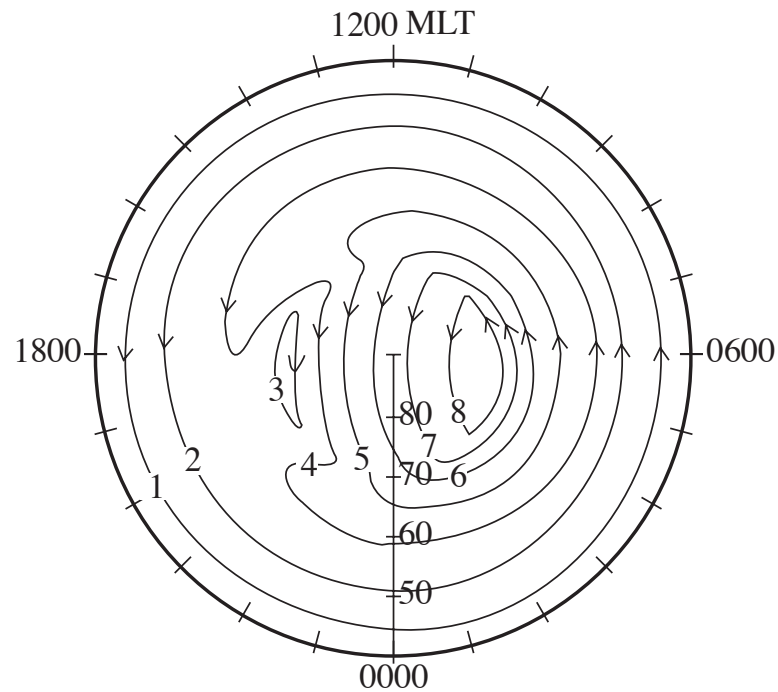

LABEL	1	2	3	4	5	6	7	8
CIRCULATION PERIOD (day)	1.00	1.01	0.10	1.34	0.50	0.31	0.18	0.11

Even simple  $E \times B$  is complex because there are two separate sources of  $E$

The ionosphere co-rotates, implying an  $E$  field, and then the magnetosphere's  $E$  field maps into the ionosphere and an atmospheric dynamo generated yet Another  $E$  field.

## GEOGRAPHIC LOCAL TIME COORDINATES

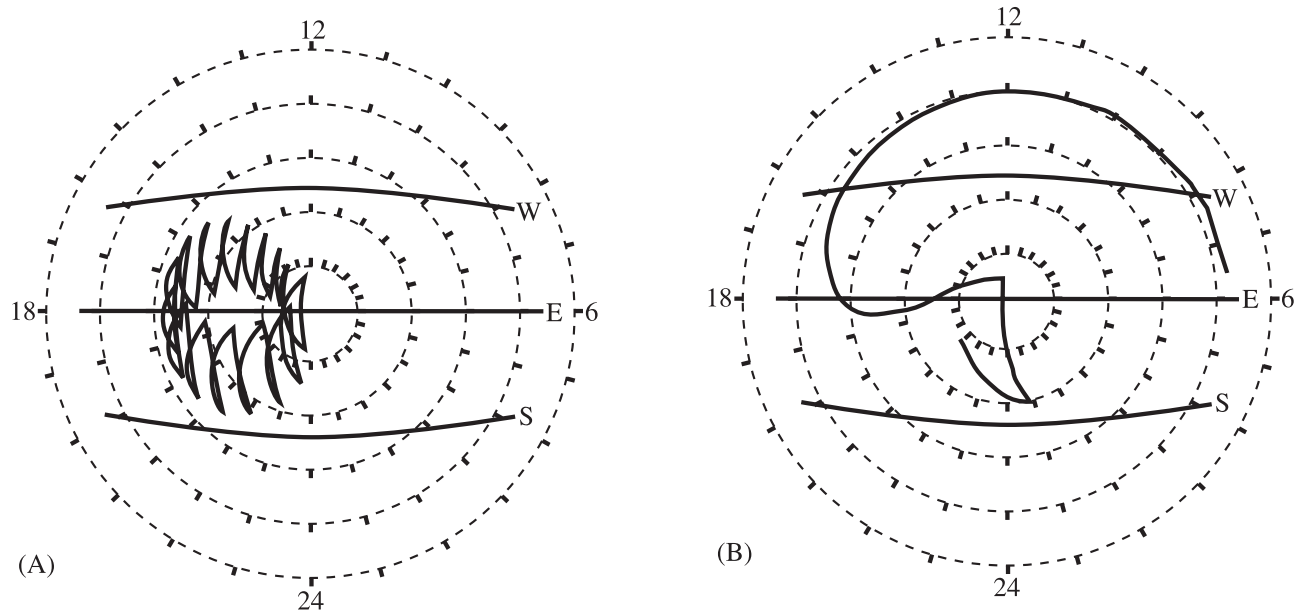

The F-region plasma as seen in a geographic local time from executes very complicated trajectories!

This means that a ground based observatory at high latitudes is not monitoring the same plasma flux tube continually, and hence the observer is not seeing the plasma evolution!

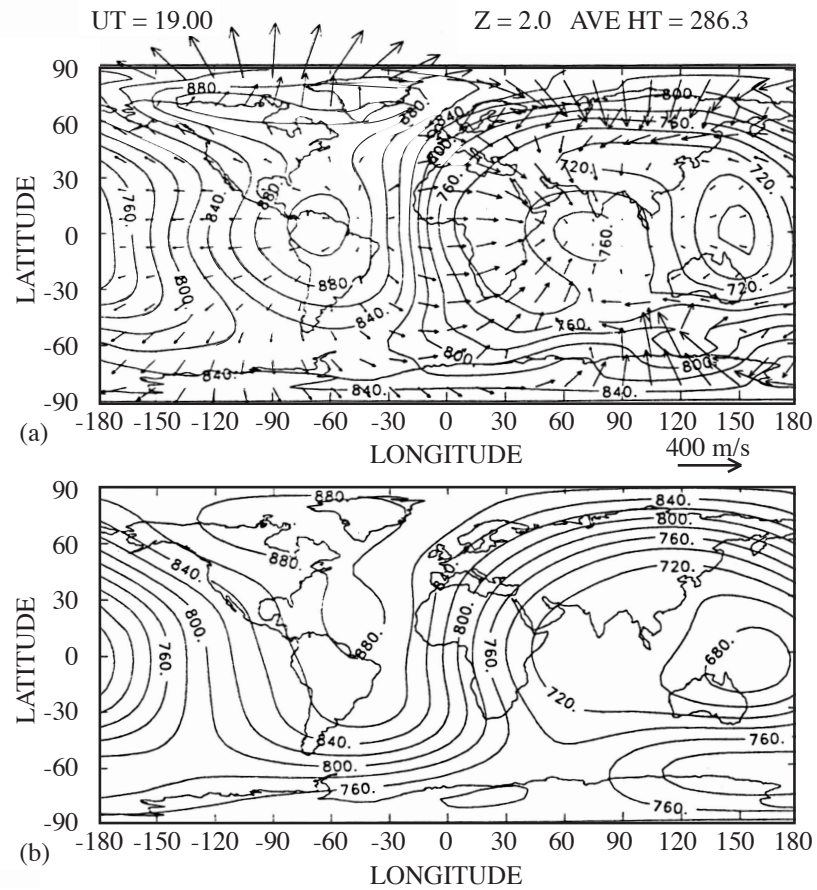

Thermospheric wind fields are altitude dependent and responsive to changes in magnetospheric energy input, STORMS.

# Joule heating: $\mathbf{J} \cdot (\mathbf{E} + \mathbf{V} \times \mathbf{B})$

## Large temperature and circulation changes in the upper thermosphere

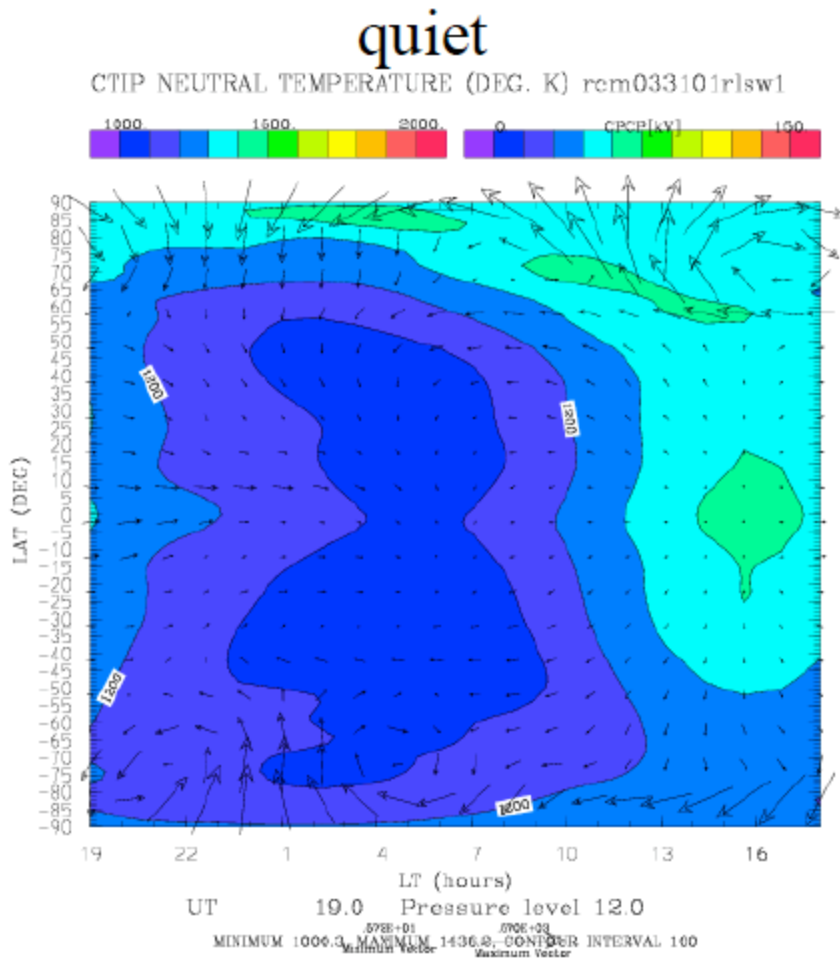

12 -

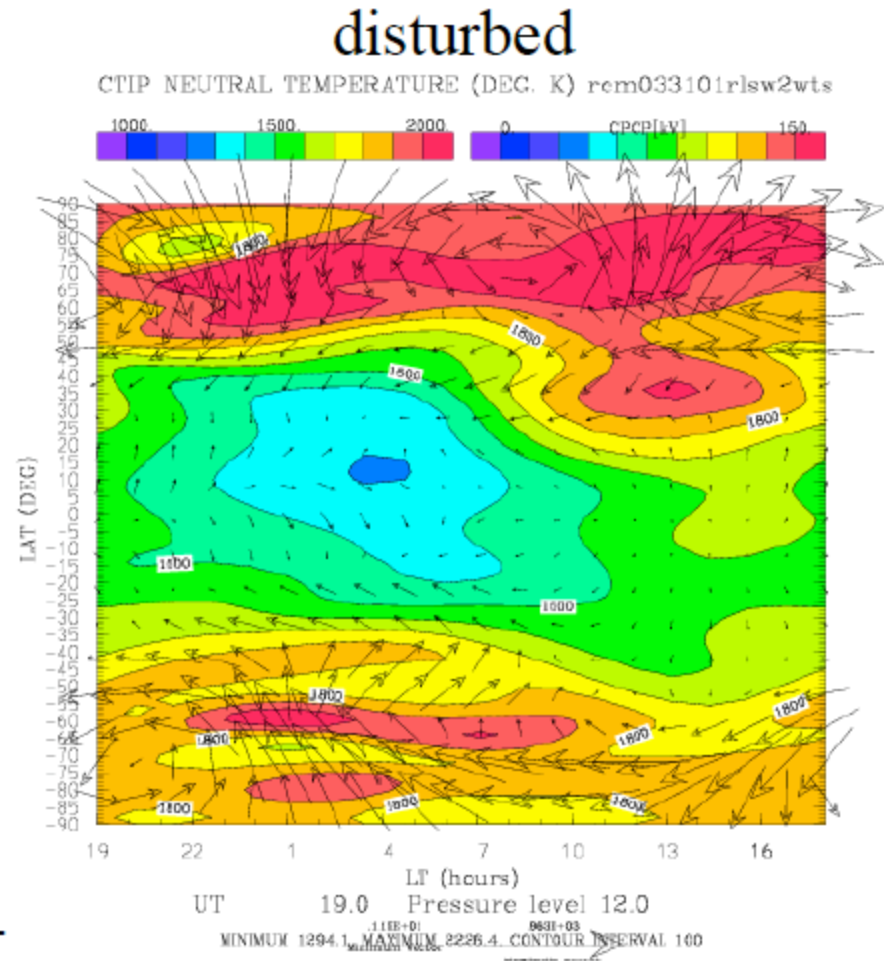

# Energy Flow

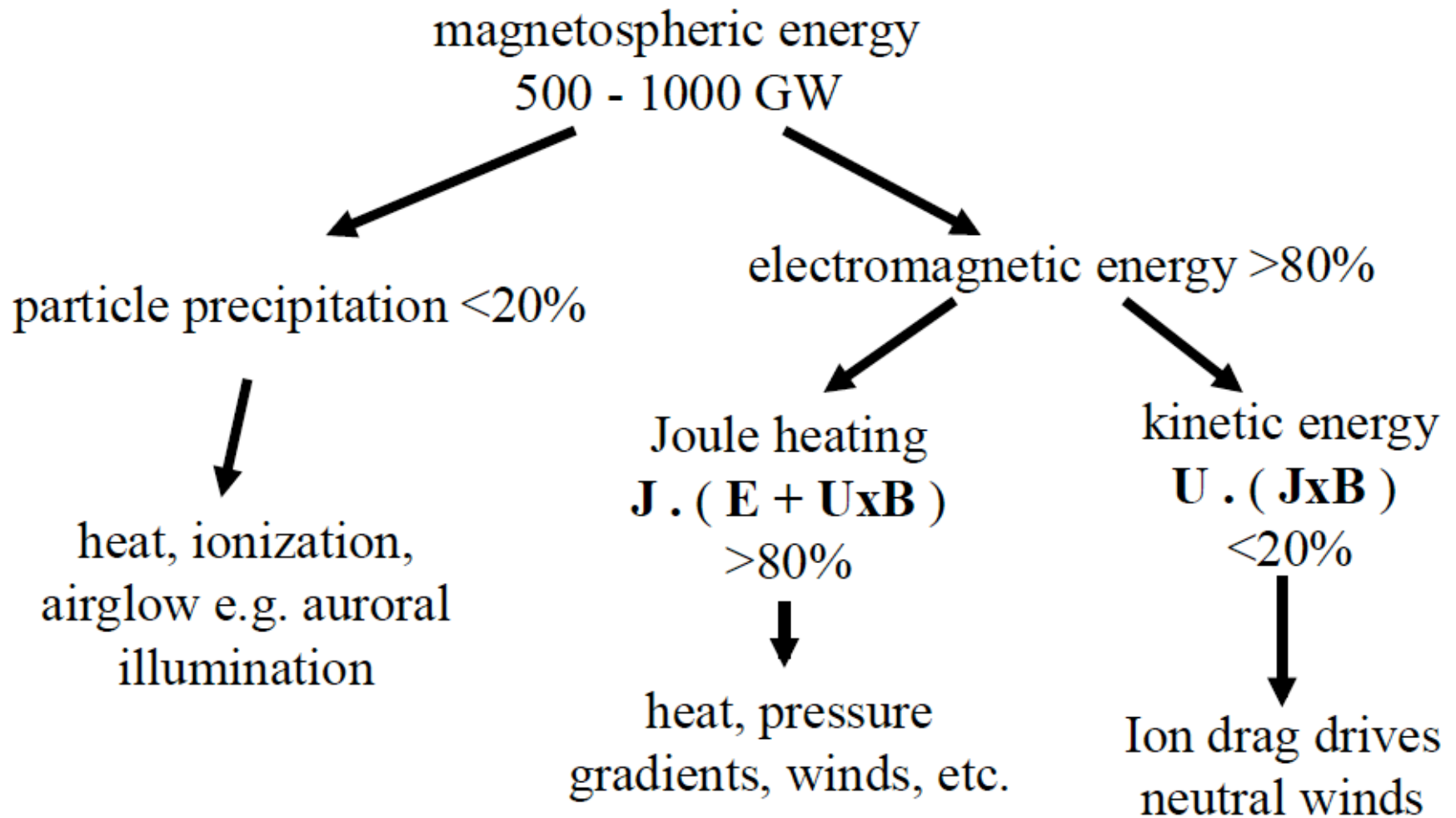



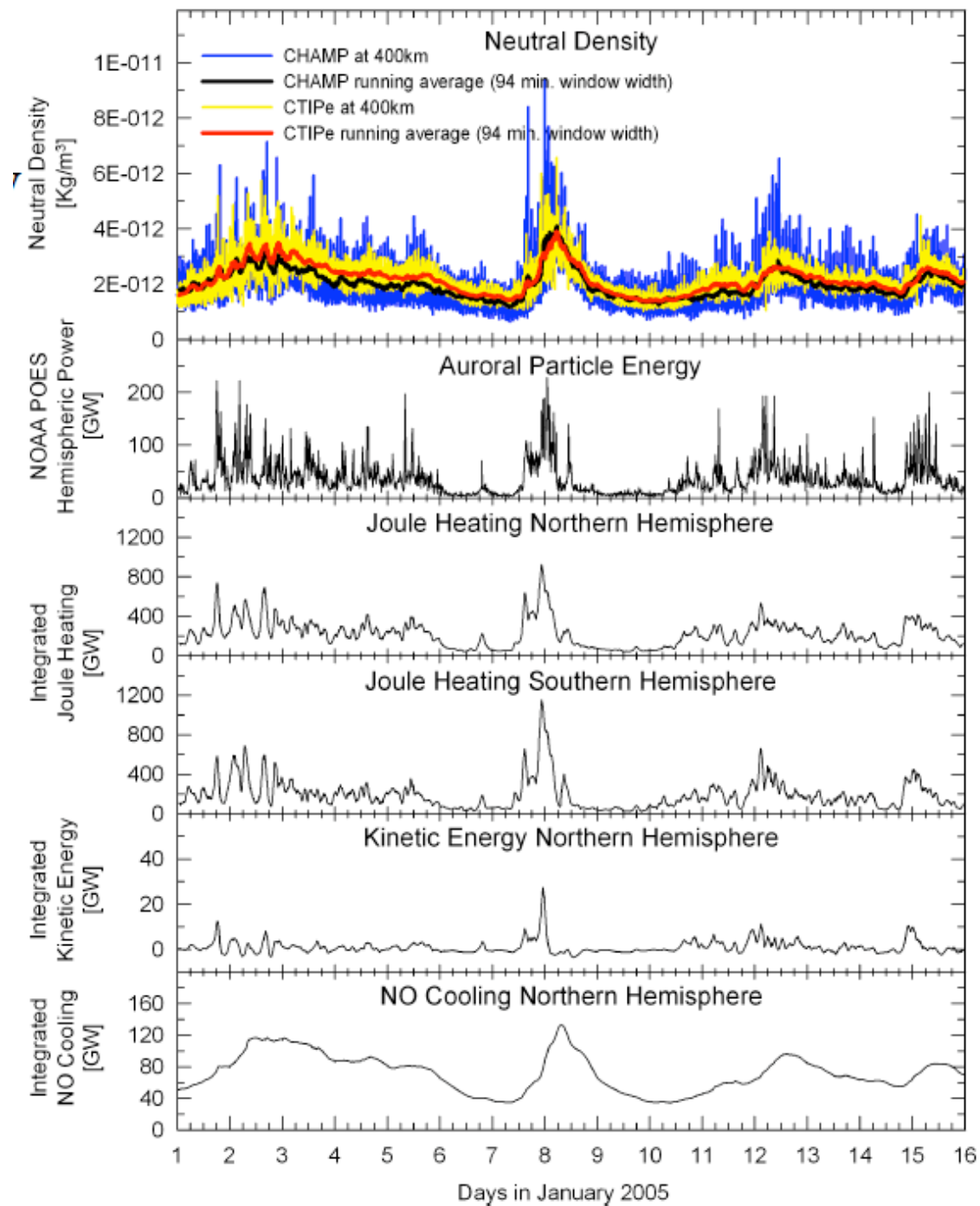

## Ion-neutral collisions in upper thermosphere frequent enough to drive high velocity neutral wind

Neutral Winds and Temperature: 300 km altitude

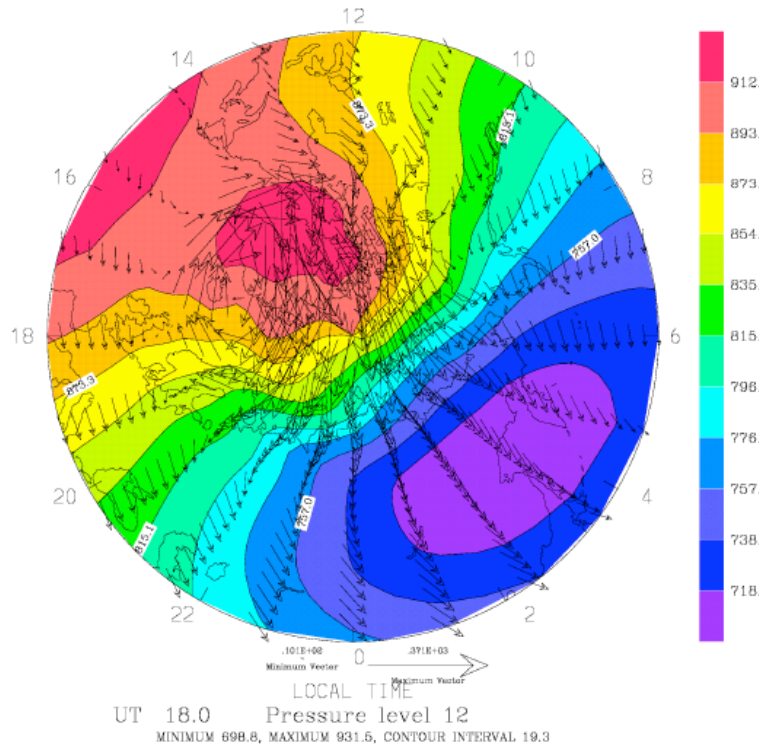

Maximum wind speed observed by DE-2  
~ 1400 m/s

### ExB ion drift and NmF2

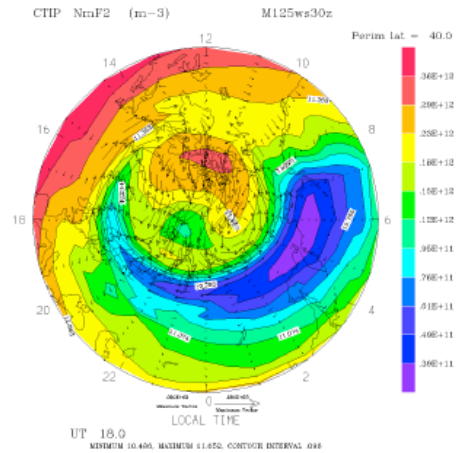

# At mid-latitudes: can be high correlation between composition changes and ion density

Increase  
in  $N_2$

Ionospheric  
depletion

Modeling

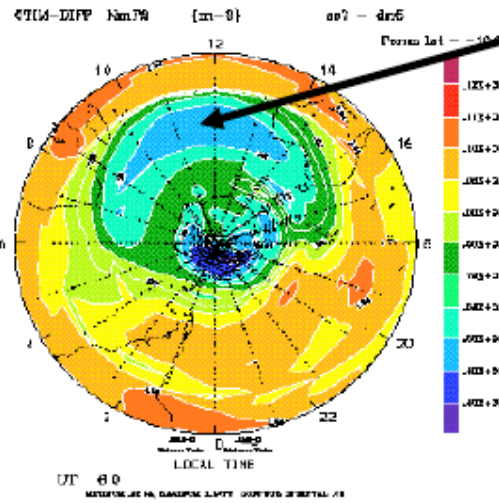
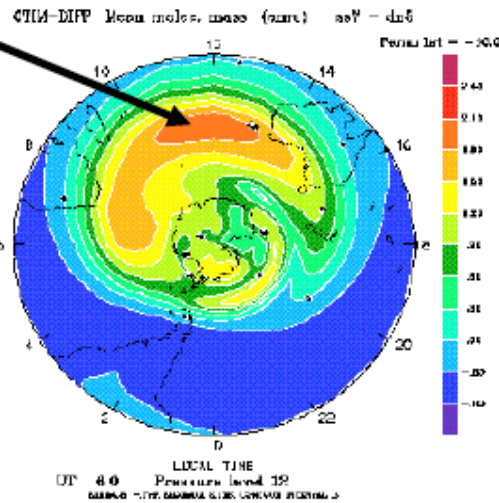

Observations

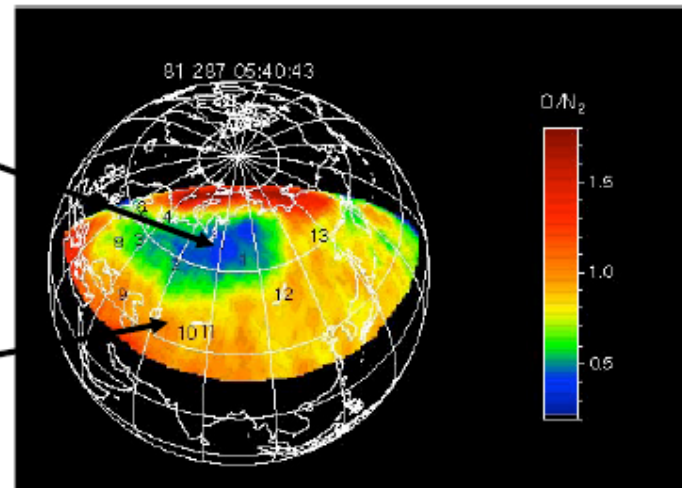
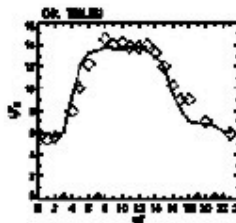
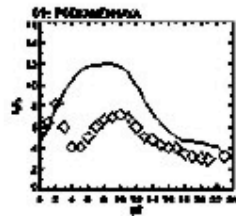

# US-TEC – SWPC IRI plus data

“positive phase”  
and tongue of ionization

“negative phase”

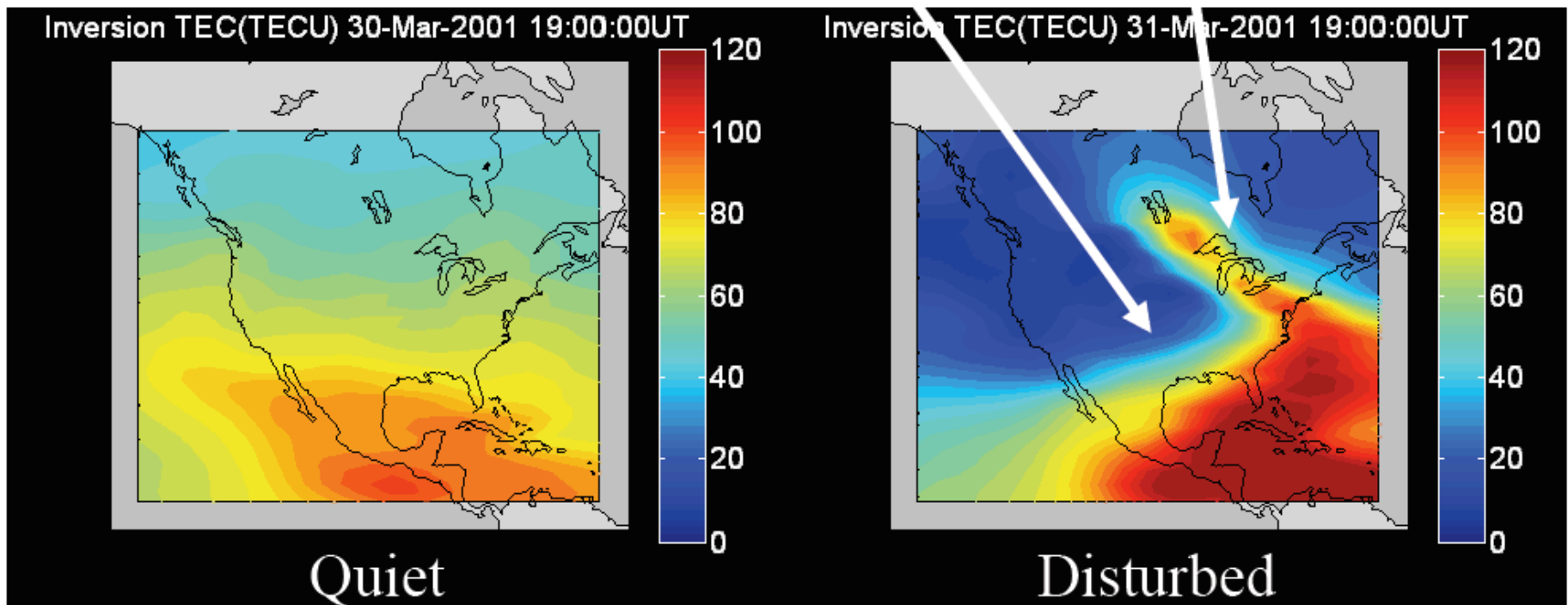

# Plasma “bulge” and Storm Enhanced Density

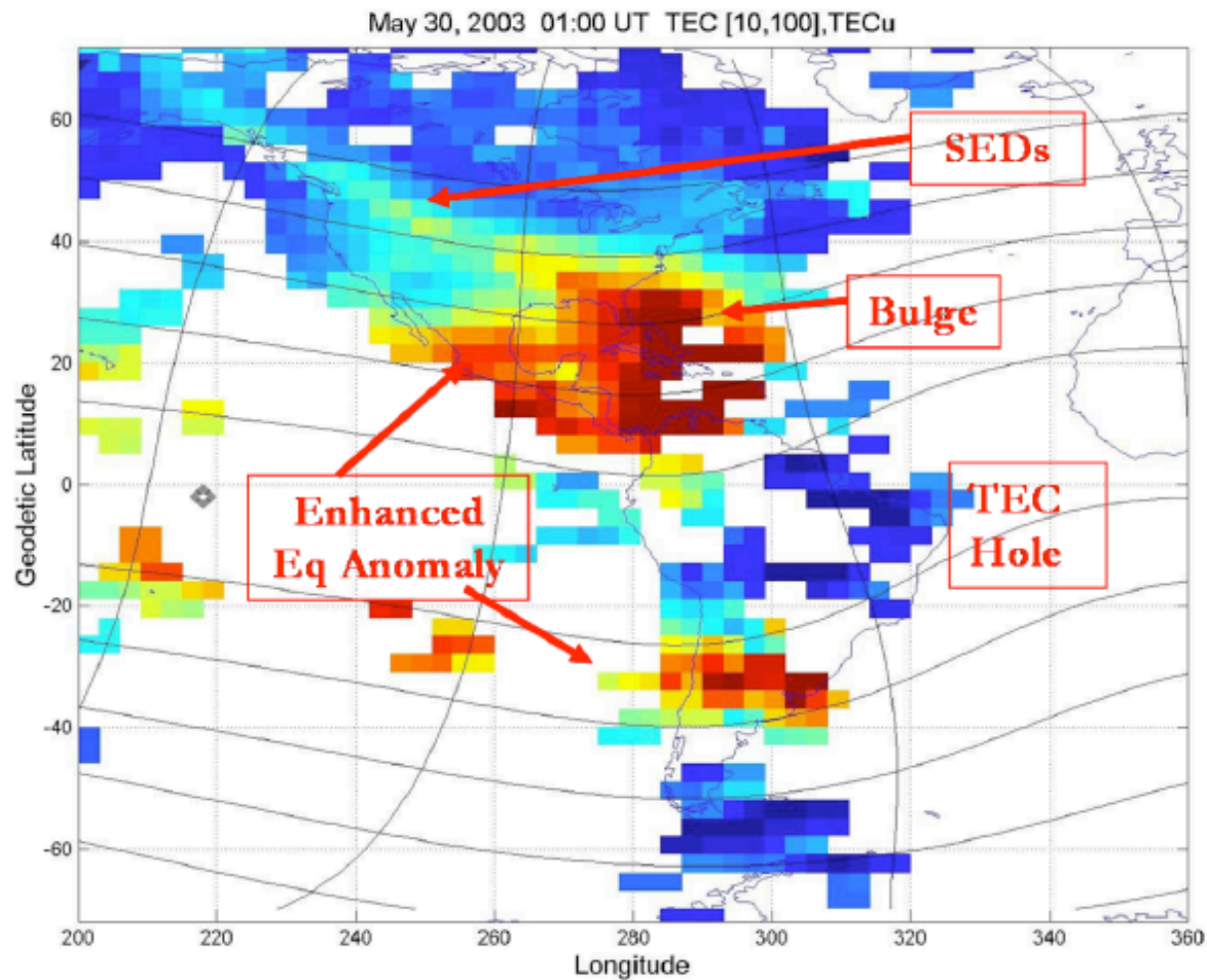

# Neutral density response to flares

(Sutton and Forbes)

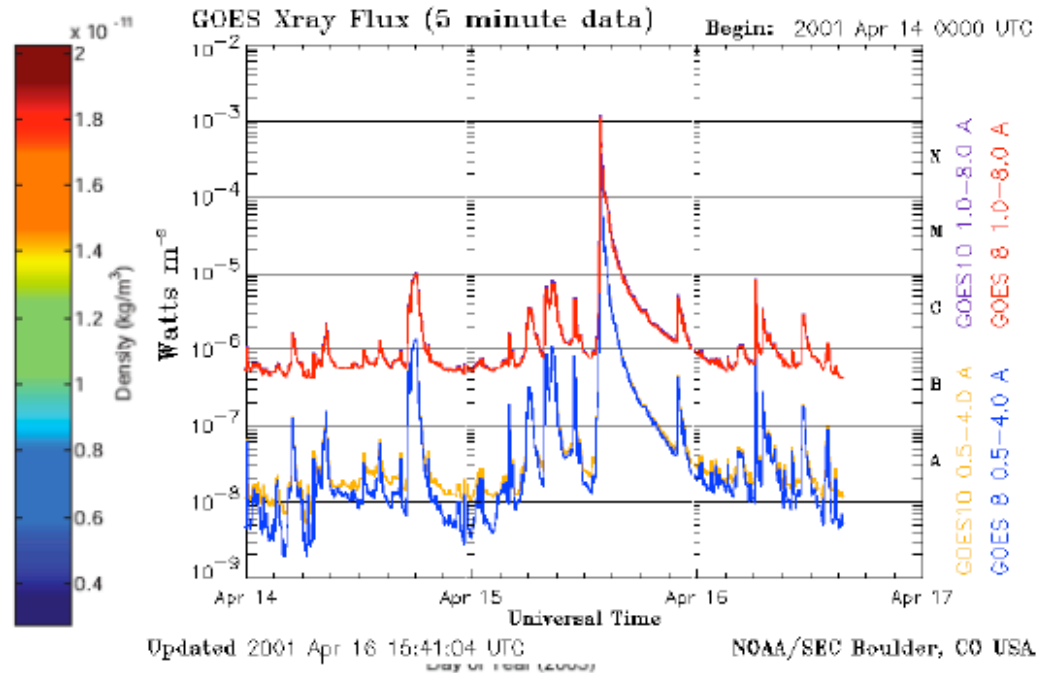
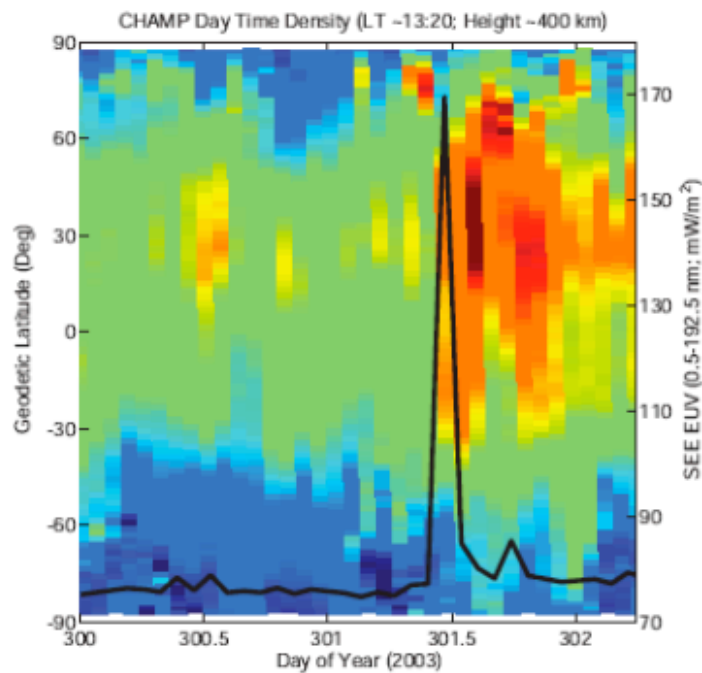

CHAMP satellite data

# Pedersen and Hall Conductivity

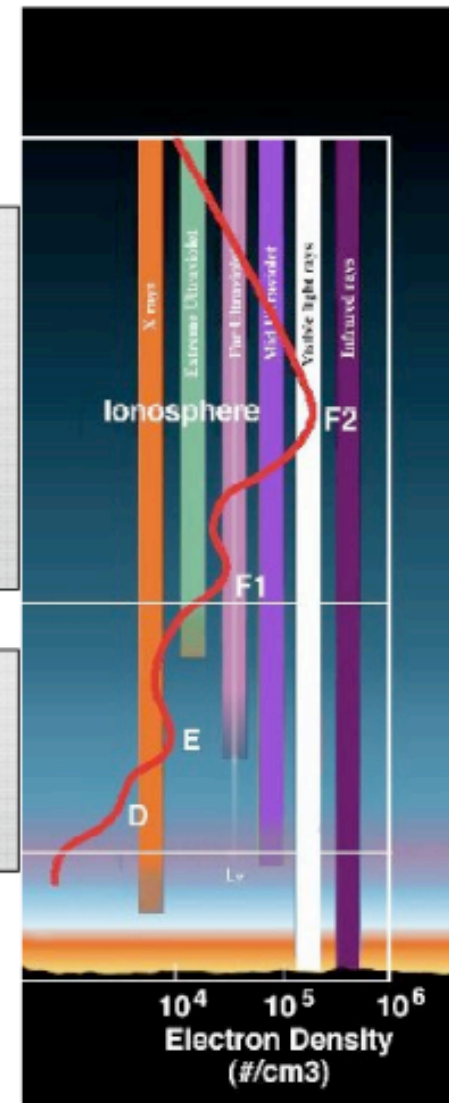
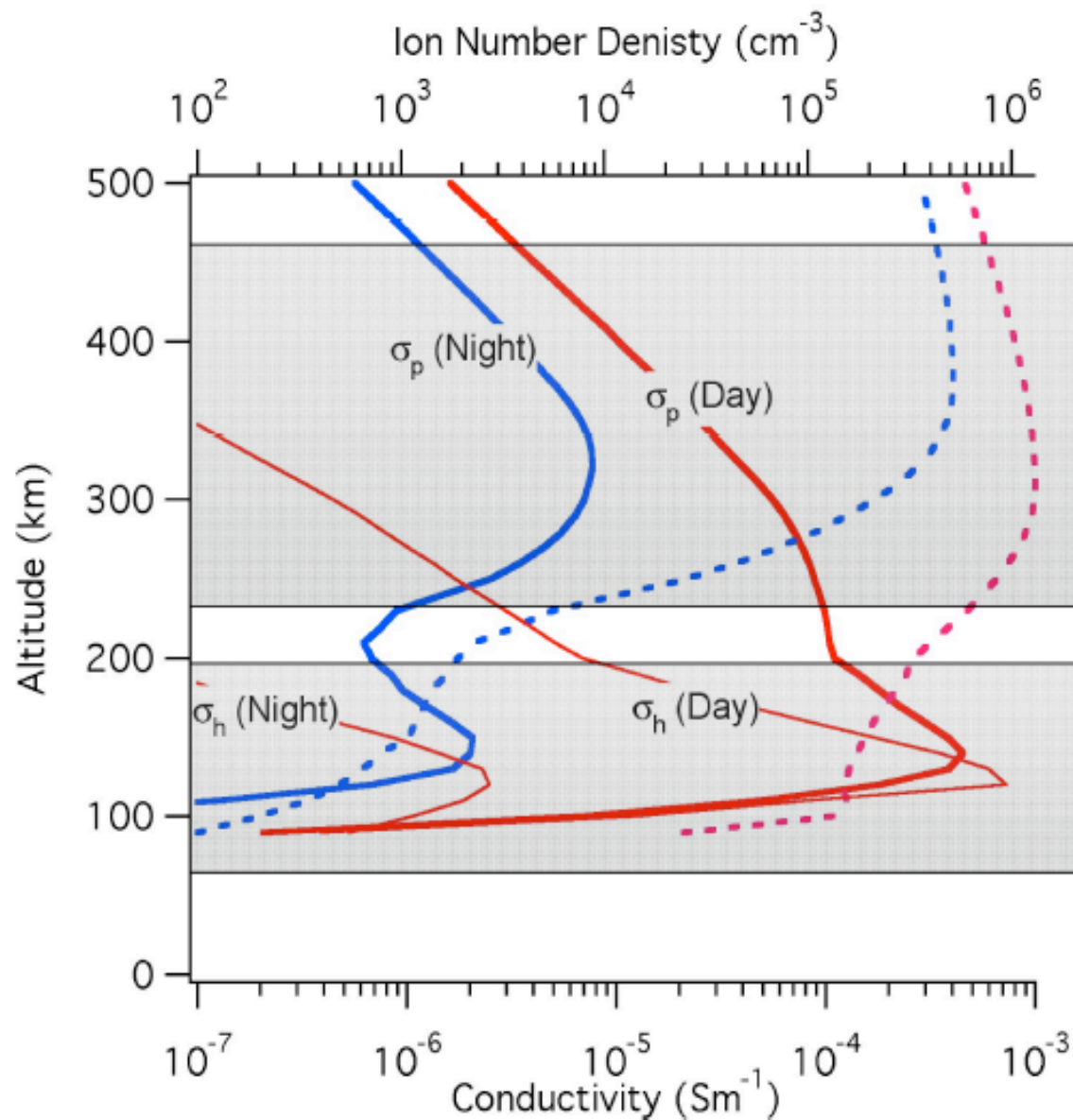

And there is lots more!